

# Installation & Maintenance Manual



**MONTIGO**<sup>®</sup>  
the art of **fireplaces**

## DelRay INDOOR DIRECT VENT GAS FIREPLACE

**DRL3613NI** 16,000 BTU/hr Natural Gas or Propane Gas

**DRL3613NI-2** 16,000 BTU/hr Natural Gas or Propane Gas

**DRL4813NI** 21,000 BTU NG /19,000 BTU Propane /hr

**DRL4813NI-2** 21,000 BTU NG /19,000 BTU Propane /hr



## ⚠ CAUTION

Installation and service must be performed by a qualified installer, service agency or the gas fitter. Check local codes and read all instructions prior to installation.

**⚠ WARNING:**  
**FIRE OR EXPLOSION HAZARD**  
Failure to follow safety warnings exactly could result in serious injury, death, or property damage.

- Do not store or use gasoline or other flammable vapors and liquids in the vicinity of this or any other appliance.
- WHAT TO DO IF YOU SMELL GAS
  - Do not try to light any appliance.
  - Do not touch any electrical switch; do not use any phone in your building.
  - Leave the building immediately.
  - Immediately call your gas supplier from a neighbour's phone. Follow the gas supplier's instructions.
  - If you cannot reach your gas supplier, call the fire department.
- Installation and service must be performed by a qualified installer, service agency or the gas fitter.

Canada

**ENERGUIDE**

Look for the **EnerGuide**  
Gas Fireplace Energy  
Efficiency Rating in this brochure

*Based on CSA P.4.1-15*



# DANGER



**HOT GLASS WILL CAUSE BURNS.**  
**DO NOT TOUCH GLASS UNTIL COOLED.**

**NEVER ALLOW CHILDREN TO TOUCH GLASS.**

A barrier designed to reduce the risk of burns from the hot viewing glass is provided with this appliance and shall be installed for the protection of children and other at-risk individuals.

## NOTICE

**Installer:** Leave this manual with the appliance. Please refer to the Montigo website for the most current version of the fireplace manual  
**Consumer:** Retain this manual for future reference. Please refer to the Montigo website for the most current version of the fireplace manual

## ⚠ WARNING

Some materials used in the manufacturing process of this product can expose you to Benzene which is known in the State of California to cause cancer and birth defects or other reproductive harm. For more information go to [www.P65warnings.ca.gov](http://www.P65warnings.ca.gov)

## Safety Alert Key

### DANGER

Indicates a hazardous situation which, if not avoided, WILL result in death or serious injury or property damage.

### WARNING

Indicates a hazardous situation which, if not avoided, COULD result in death or serious injury or property damage.

### CAUTION

Indicates a hazardous situation which, if not avoided, WILL result in minor or moderate injury.

### NOTICE

Indicates practices that are important, but not related to personal injury.

## Efficiency

Efficiency listing	
MODEL	P.4, 1-15 Efficiency*
DRL3613NI	71
DRL3613LI	71
DR3613NI-2	71
DR3613LI-2	71
DRL4813NI	63
DRL4813LI	60
DRL4813NI-2	63
DRL4813LI-2	60

## Introduction

### Congratulations on your purchase of a Montigo Fireplace.

With over 30 years of experience, Montigo is committed to providing you with a gas fireplace that is not only a beautiful addition to your space, but that is also designed and manufactured to the highest safety, reliability and engineering standards.

We strongly encourage you to read and carefully follow the instructions laid out in this Installation, Operation and Maintenance Manual and retain it for your future reference. Pay special attention to all cautions, warnings, and notices throughout this manual intended to ensure your safety.

This manual covers installation, operation and maintenance. Lighting, operation and care of this fireplace can be easily performed by the homeowner. All installation and service work should be performed by a qualified or licensed installer, plumber or gas fitter as certified by the state, province, region or governing body where the fireplace is being installed.

This installation, operation and maintenance manual is applicable to the models described in Table 1. Refer to your rating plate to verify included options.

### Warranty and Installation Information: (See Appendix B)

The Montigo warranty will be voided by, and Montigo disclaims any responsibility for, the following actions:

- Modification of the fireplace and/or components including Direct-Vent assembly or glass doors.
- Use of any component part not manufactured or approved by Montigo in combination with this Montigo fireplace system.
- Installation other than as instructed in this manual.
- Consult your local Gas Inspection Branch on installation requirements for factory-built gas fireplaces. Installation & repairs should be done by a qualified contractor.

BTU Listing						
MODEL	Natural Gas	Liquid Propane	BTU / hr	Linear Burner w/ Glass Accessories	SIT Elect. Ignition	SIT Elect. Ignition BASIC
DRL3613NI	X		16,000	X		X
DRL3613LI		X	16,000	X		X
DR3613NI-2	X		16,000	X	X	
DR3613LI-2		X	16,000	X	X	
DRL4813NI	X		21,000	X		X
DRL4813LI		X	19,000	X		X
DRL4813NI-2	X		21,000	X	X	
DRL4813LI-2		X	19,000	X	X	

Figure 1 DR and DR Builders Specifications

### CAUTION

Young children should be carefully supervised when they are in the same room as the appliance. Toddlers, young children, and others may be susceptible to accidental contact burns. A physical barrier is recommended if there are at-risk individuals in the house. To restrict access to a fireplace or stove, install an adjustable safety gate to keep toddlers, young children, and other at-risk individuals out of the room and away from hot surfaces

This appliance may be installed in an aftermarket, permanently located, manufactured home (USA only) or mobile home, where not prohibited by local codes.

This appliance is only for use with the type of gas indicated on the rating plate. A conversion kit is supplied with the appliance.

## Contents

<b>Safety Alert Key</b> .....	<b>2</b>	<b>Section 5: Installing the gas line</b> .....	<b>18</b>
<b>Introduction</b> .....	<b>2</b>	Fuel Type.....	18
<b>Efficiency</b> .....	<b>2</b>	Gas Pressure .....	18
Section A: Before You Begin .....	4	Section 5-3: GAS CONNECTION .....	18
Installation Checklist .....	4	<b>Section 6: Finishing</b> .....	<b>19</b>
Standard Installation Checklist.....	5	Finishing Around the Fireplace .....	19
Rating Plate Sample .....	6	Cement Board Install.....	19
<b>Section 1: Dimensions</b> .....	<b>7</b>	<b>Section 8: Removing &amp; Installing the Screen / Door</b> .....	<b>20</b>
DelRay Dimensions .....	7	Removing the Screen.....	20
<b>Section 2: Framing</b> .....	<b>8</b>	Reinstalling the Screen.....	20
In Wall and Corner Dimensions .....	8	Removing the door .....	20
Alcove above the fireplace .....	8	Reinstalling the door.....	20
Clearances.....	9	<b>Propane Conversion</b> .....	<b>21</b>
<b>Section 3: Venting</b> .....	<b>9</b>	<b>Section 9: Installing the Accessories</b> .....	<b>23</b>
<b>Section 3-3-1: Venting Layout</b> .....	<b>10</b>	Installing the Fireglass or Optional Glass Media.....	23
Wall and Roof mounted venting .....	10	DelRay 36" Optional Log Kit Installation .....	23
<b>Section 3-2: Installing a Roof Mounted Direct Vent Termination for 4"/7" (MVTK-1)</b> .....	<b>11</b>	Propane Driftwood Layout.....	23
Section 3-2-1: Venting Layout .....	11	Natural Gas Driftwood Layout.....	23
<b>Section 3-3: Installing a Wall Mounted Termination 4"/7" .....</b>	<b>12</b>	DelRay 48" Optional Log Kit Installation .....	24
Section 3-3-2: Venting Components.....	13	Propane Driftwood Layout.....	24
Section 3-3-2.2: DuraVent DirectVent Pro 4" x 6 5/8" Venting Components.....	14	Natural Gas Driftwood Layout.....	24
<b>Section 3-3-3: Heat Shields 4"/7" .....</b>	<b>15</b>	<b>Section 10: Cleaning and Maintenance</b> .....	<b>26</b>
<b>Section 4: Wiring</b> .....	<b>16</b>	General.....	26
DRL**13 (N/L) I Wiring Diagram .....	16	Cleaning .....	26
Installation of the wall switch.....	16	Pilot Burner Adjustment. ....	26
DR**13 (N/L) I-2 Wiring Diagram.....	17	Troubleshooting.....	27
Installation of Electrical Supply .....	17	Direct Vent Outdoor Applications .....	27
		Notes .....	27
		<b>Appendix A: Venting Terminations</b> .....	<b>28</b>
		<b>Appendix B: Warranty</b> .....	<b>29</b>
		<b>Appendix B: Warranty Continued</b> .....	<b>30</b>
		<b>Appendix C: Amendment</b> .....	<b>31</b>

## Section A: Before You Begin

### IMPORTANT MESSAGE: SAVE THESE INSTRUCTIONS

The DelRay fireplaces must be installed in accordance with these instructions. Carefully read all the instructions in this manual first. Consult the Local Gas Branch to determine the need for a permit prior to starting the installation. It is the responsibility of the installer to ensure this fireplace is installed in compliance with the manufacturers instructions and all applicable codes.

### NOTICE

Do not use this appliance if any part has been under water. Immediately call a qualified service technician to inspect the appliance and to replace any part of the control system and any gas control that has been under water

### NOTICE

Due to high temperatures, the appliance should be located out of traffic and away from furniture and draperies

### NOTICE

Children and adults should be alerted to the hazards of high surface temperature and should stay away to avoid burns or clothing ignition

### NOTICE

A barrier designed to reduce the risk of burns from the hot viewing glass is provided with this appliance and shall be installed for the protection of children and other at-risk individuals

**This appliance may be installed as an OEM installation in a manufactured home(USA only) or mobile home and must be installed in accordance with the manufacturers instructions and the *Manufactured Home Construction and Safety Standard, Title 24 CFR, Part 3280, in the United States, or the Standard for Installation in Mobile Homes, CAN/CSA Z240 MH, in Canada.***

**This appliance is only for use with the type(s) of gas indicated on the rating plate. A conversion kit is supplied with the appliance.**

## Installation Checklist

- Determine the desired install location of your fireplace.
- See Section 1, Dimensions on Page 6, and refer to the Framing Section 2 for details.
- Select the location of your termination and resulting vent run.
- Should it be impossible to meet the venting requirements laid out in Section 3: Venting, please contact your Montigo dealer regarding the use of a Montigo Power Vent.
- Lay out the Vent run; calculating the required elbows and straight runs of 4"/7" flex and/or rigid pipe.
- Layout Electrical Requirements refer to Section 4: Wiring, for Details.
- Refer to Section 5: Installing the Gas Line, for details on the gas connection and access.
- Refer to local codes and guidelines for installation requirements.
- Installation and repairs should be done by a qualified contractor and must conform to:
- Installations in Canada must conform to the local codes or in the absence of local codes to the current version of Natural Gas and Propane Installation Code, CSA B149. Electrical installations must conform to the local codes or, in the absence of local codes, to the current version of Canadian Electrical Code, CSA C22.1.1
- Installations in the USA must conform to the local codes or in the absence of local codes to the current version of National Fuel Gas Code, ANSI Z223.1/NFPA 54. Electrical installations must conform to the local codes or, in the absence of local codes, to the current version of the National Electrical Code, ANSI/NFPA 70. See Appendix C for installation within the State of Massachusetts

### NOTICE

Clothing or other flammable material should not be placed on or near the appliance

### NOTICE

Installation and repair should be done by a qualified service person. The appliance should be inspected before use and at least annually by a professional service person. More frequent cleaning might be required due to excessive lint from carpeting, bedding material, etc. It is imperative that control compartments, burners, and circulating air passageways of the appliance be kept clean

## Standard Installation Checklist



This standard installation checklist is to be used by the installer in conjunction with, not instead of, the instructions contained within this installation manual.

Customer _____	Date Installed: _____
Install Address: _____	Location of Fireplace: _____
_____	Installer: _____
Model(circle one): DRL3613NI, DRL3613NI-2, DRL4813NI, DRL4813NI-2	Dealer Phone: _____
DRL3613LI, DRL3613LI-2, DRL4813LI, DRL4813LI-2	Serial #: _____



	YES	NO	IF NO, WHY NOT?
<b>Appliance Install: Section 2</b>			
Framing complies with install manual.			
Standoffs have been installed.			
Proper clearances have been maintained.			
<b>Venting: Section 3</b>			
Venting configuration complies with vent diagrams.			
Venting installed, fastened, and secured in place maintaining proper clearance.			
Firestops installed.			
Exterior wall/roof flashing installed and sealed in compliance with local building code.			
Terminations installed and sealed in compliance with local building code.			
Direct vent termination is highest point in vent assembly.			
<b>Wiring/Electrical: Section 4</b>			
Unswitched power provided to the appliance PPO box.			
Low voltage wire connected to dry contact wall switch (non-powered)*			
<b>Gas: Section 5</b>			
Proper appliance for fuel type.			
Was a conversion performed?			
Leak check performed & inlet pressure verified.			
<b>Finishing: Section 6</b>			
Only non-combustible materials installed in non-combustible areas.			
Clearances meet installation manual requirements			
Mantels and/or projections comply with install manual			
<b>Appliance Setup: Section 7 through 9</b>			
Media, door, and screen installed according to install manual			
Manual given to home owner.			
Started appliance and verified no gas leaks exist.			
<b>Comments:</b>			

\*Only applicable for Builders Series

## Rating Plate Sample

Do Not Remove This Label  
N'enlevez Pas Cette Étiquette

Do Not Remove This Label  
N'enlevez Pas Cette Étiquette

**Type:** Vented Gas Fireplace Heater

**Model No. / Modèle:** DRL3613NI-2

**Serial No.:** X-XXXXXX-XXXXXX

**Distributed by / distribué par:** Canadian Heating Products Inc., Langley BC, (www.montigo.com)  
Montigo DelRay Corp., Ferrndale, WA, (www.montigo.com)

**Tested To / Examiné A:** ANSI Z21 88-2016 / CSA233-2016

**Electrical Rating / Estimation Électrique:** 15V / 1Ph / 60Hz / less than 12A  
**Altitude Rating / Estimation D'Altitude:** N & H (0 - 4500 ft. / 0 - 1371 m.)

**Fuel Type / Type De Carburant:**  Natural Gas / Gaz Naturel  
 Propane / Gaz Propane



Max. Input BTU/H	Min. Input BTU/H	Output / Rendement BTU/H	Orifice Size / Taille D'Orifice Front/Avant Rear/Derrière	Gas Mantle/Field Pressure / Pression D'Admission Du Gaz	Min. Gas Supply Pressure / Min. Pression D'Alimentation Du Gaz
16,000	16,000	N/A	49 DWS / N/A	3.5" W.C.	5.5" W.C.
16,000	16,000	N/A	1.15 mm / N/A	10" W.C.	13" W.C.

**FOR USE WITH GLASS DOORS AND SCREENS CERTIFIED WITH THE APPLIANCE ONLY**  
Pour utilisation avec portes de verre and écrans de certifiés avec l'appareil seulement



**Refer to installation manual for more information.**  
Référez-vous au manuel d'installation pour plus d'information.

Made in China  
Fabriqué en Chine

Figure 1.1 Rating Plate for DelRay DRL3613NI-2

Do Not Remove This Label  
N'enlevez Pas Cette Étiquette

Do Not Remove This Label  
N'enlevez Pas Cette Étiquette

**Type:** Vented Gas Fireplace Heater

**Model No. / Modèle:** DRL4813NI-2

**Serial No.:** X-XXXXXX-XXXXXX

**Distributed by / distribué par:** Canadian Heating Products Inc., Langley BC, (www.montigo.com)  
Montigo DelRay Corp., Ferrndale, WA, (www.montigo.com)

**Tested To / Examiné A:** ANSI Z21 88-2016 / CSA233-2016

**Electrical Rating / Estimation Électrique:** 15V / 1Ph / 60Hz / less than 12A  
**Altitude Rating / Estimation D'Altitude:** N & H (0 - 4500 ft. / 0 - 1371 m.)

**Fuel Type / Type De Carburant:**  Natural Gas / Gaz Naturel  
 Propane / Gaz Propane

Max. Input BTU/H	Min. Input BTU/H	Output / Rendement BTU/H	Orifice Size / Taille D'Orifice Front/Avant Rear/Derrière	Gas Mantle/Field Pressure / Pression D'Admission Du Gaz	Min. Gas Supply Pressure / Min. Pression D'Alimentation Du Gaz
21,000	21,000	N/A	2.15 mm / N/A	3.5" W.C.	5.5" W.C.
19,000	19,000	N/A	1.3 mm / N/A	10" W.C.	13" W.C.

**FOR USE WITH GLASS DOORS AND SCREENS CERTIFIED WITH THE APPLIANCE ONLY**  
Pour utilisation avec portes de verre and écrans de certifiés avec l'appareil seulement

**Refer to installation manual for more information.**  
Référez-vous au manuel d'installation pour plus d'information.

Made in China  
Fabriqué en Chine

Figure 1.2 Rating Plate for DelRay DRL4813NI-2

## Section 1: Dimensions

### DelRay Dimensions

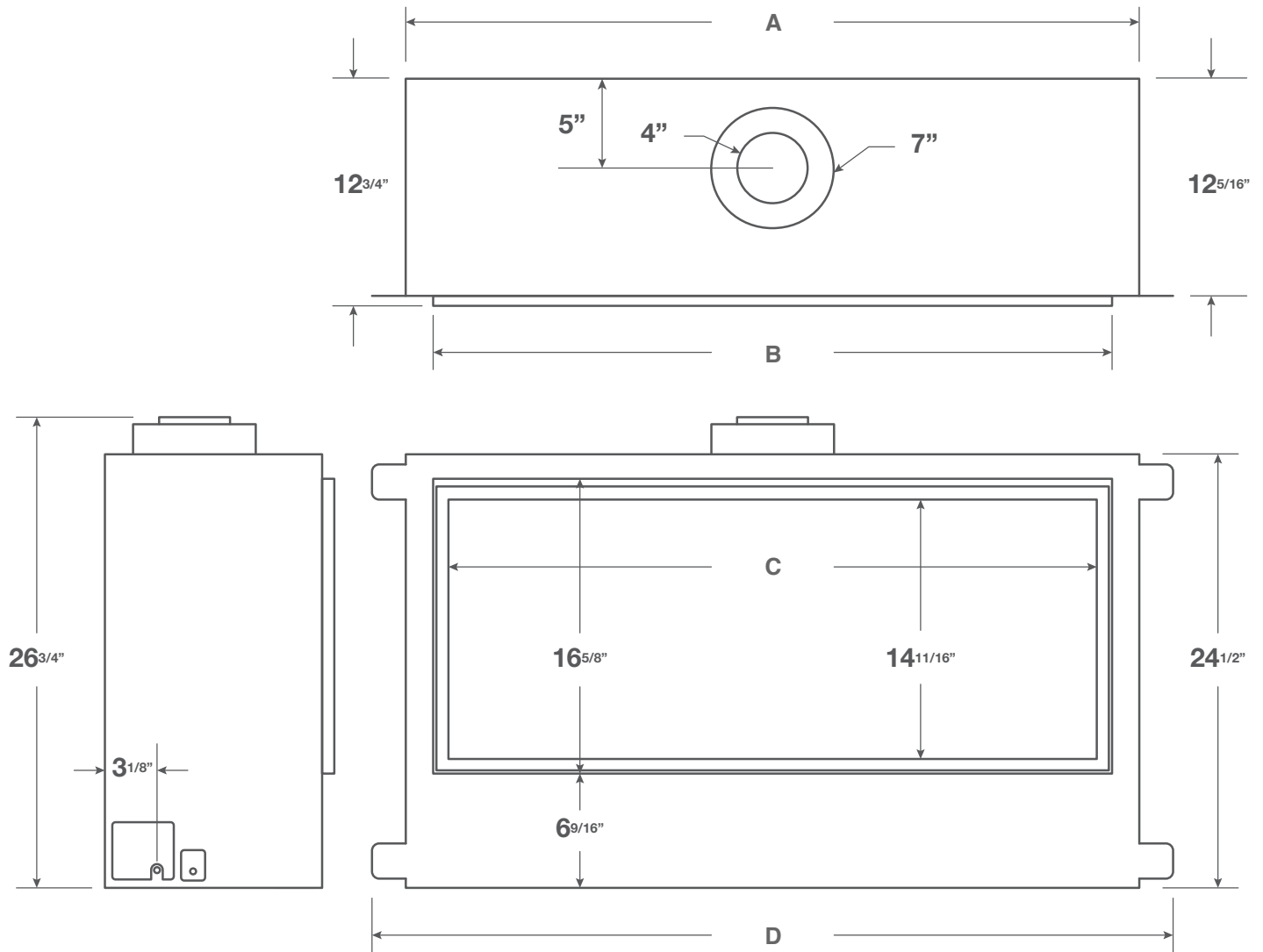

Figure 2. DelRay Fireplace dimensions (Tolerance  $\pm 1/8"$ ).

DRL*3613 DIMENSIONS			
A	B	C	D
41 3/8"	38 3/8"	36 1/2"	45 1/4"

DRL*4813 DIMENSIONS			
A	B	C	D
53 3/16"	50 3/16"	48 1/2"	57 1/4"

## Section 2: Framing

### In Wall and Corner Dimensions

1). Frame in the enclosure for the unit with framing materials. The framed opening for the assembled fireplace shown below in table

NOTE: When constructing the framed opening, please ensure there is access to install the gas line when the unit is installed

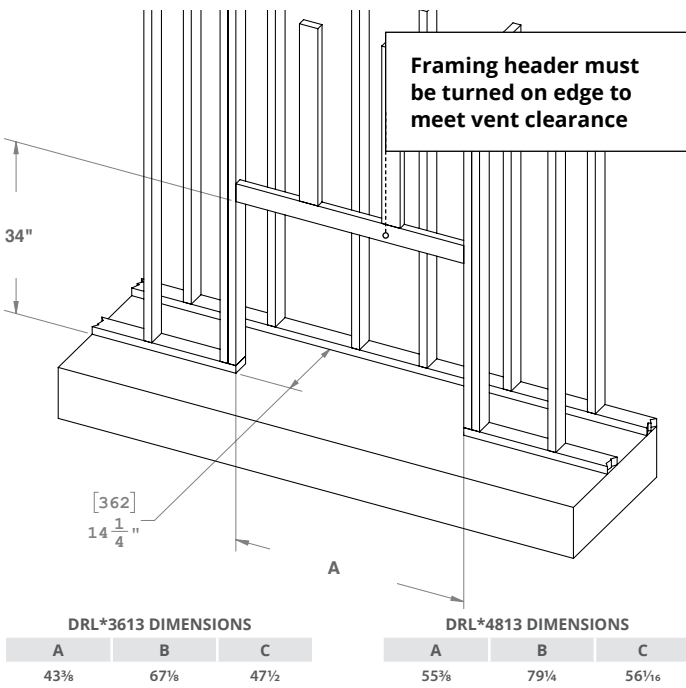

Figure 3.a Framing dimensions table

\* When sheetrock is used behind the fireplace, framing depth may be increased by 1/2".

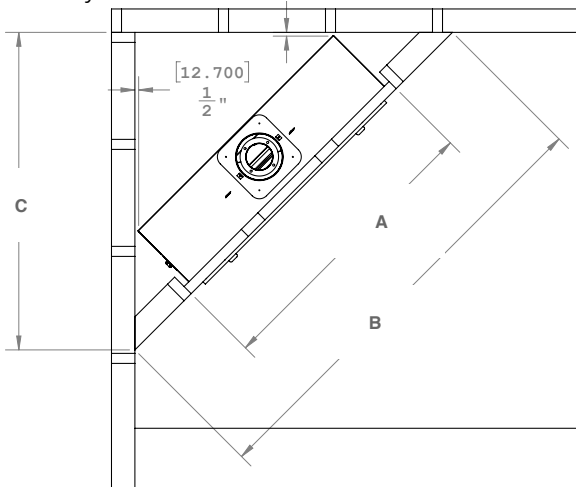

Figure 3.b Framing dimensions (Straight wall & Corner Installation).

### Alcove above the fireplace

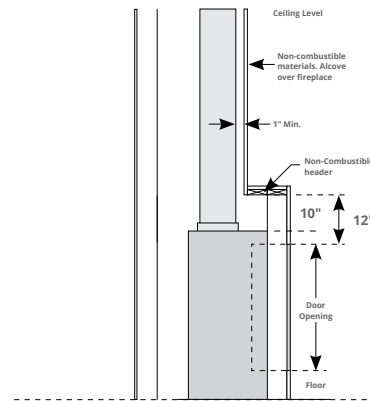

Figure 3.d Non-combustible Framing for shelves over the fireplace

### ⚠ WARNING

When this appliance is installed directly on ANY combustible other than wood flooring (carpet, vinyl, etc.). It must be installed on an equivalent wood or metal panel. This material must extend the full width and depth of the appliance.

### NOTICE

Clearances must be in accordance with local installation codes and the requirements of the gas supplier



## Section 3: Venting

### Clearances

When installing a shelf over the top of the fireplaces, the following guidelines must be adhered to:

MODEL	Top - Top vent †	Rear	Sides	Floor	Mantel	Vent Pipe
DRL**3613*1	21"	2"	1"	0"	6"	1" all around 2" on the horizontal
DRL**4813*1	21"	2"	1"	0"	6"	1" all around 2" on the horizontal

Figure 4. Combustible Wall Clearances

#### NOTES:

† Clearance from top of fireplace to a ceiling within the fireplace enclosure.

Montigo offers a variety of direct venting and termination options. The direct vent termination location **MUST** be selected such that it is the highest point in the venting assembly. It should also be selected such that it provides the shortest vent run possible. Should it be impossible to ensure that the termination is the highest point or to meet the venting guidelines laid out below please contact your Montigo dealer to discuss power venting options.

#### Notes For Planning Venting:

- Venting originates from the top of the unit
- Venting can terminate through the roof or through an exterior wall.
- Refer to Appendix A - Termination Locations to ensure the planned termination location is acceptable.
- Once the termination location has been established, refer to the appropriate section below for installation details
- All fireplaces shipped from the factory are top vent.
- **Silicone** application is **NOT** required when joining Montigo vent pipes and components.

### NOTICE

Under no circumstances can Montigo flex venting be cut to accommodate an installation. Use an alternative length to complete your vent run. (Excluding flex included in the MVK05)

#### MFVK05

MFVK05 Flex Vent Kit is a standalone 5 ft. vent kit that cannot be combined with Montigo Flex or Montigo Rigid pipe to extend beyond the 5ft of flex included in this kit. The Flex in this kit can be cut down if shortening is required. Any other venting configuration beyond the 5ft included in the MVK05 kit will require going to either Montigo Rigid pipe or Montigo Flex pipe referenced in the manual pages Venting section.



Figure 4.a MFVK05 Flex Vent Kit

## Section 3-3-1: Venting Layout

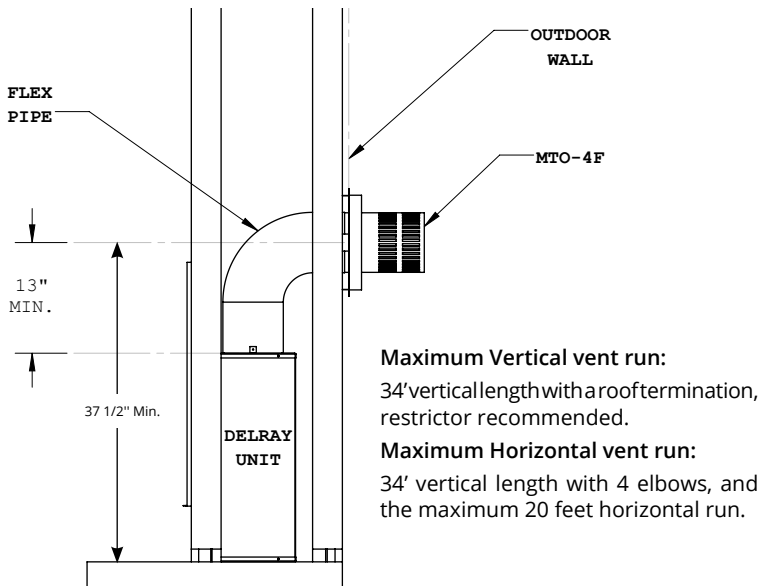

Figure 4.bb Minimum Horizontal vent run (Flex)

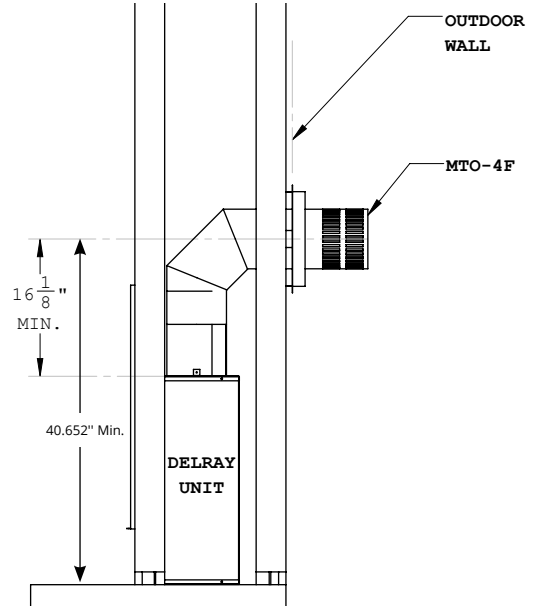

Figure 4.bb Minimum Horizontal vent run (Rigid)

## Wall and Roof mounted venting

**34' MAXIMUM VERTICAL HEIGHT**

**20' MAXIMUM HORIZONTAL OFFSETS**

**4 MAXIMUM 90° ELBOWS PERMITTED**

The minimum vent system for horizontal termination must consist of:  
13" to vent center, then straight out the wall (using flex kit)

The maximum vent system consists of:

34' vertical length with 4 - 90° bends and a 20' horizontal length (measured to center of pipe)

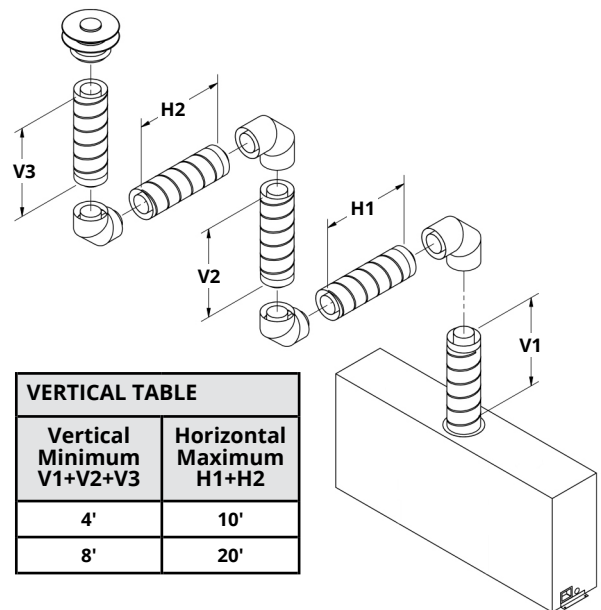
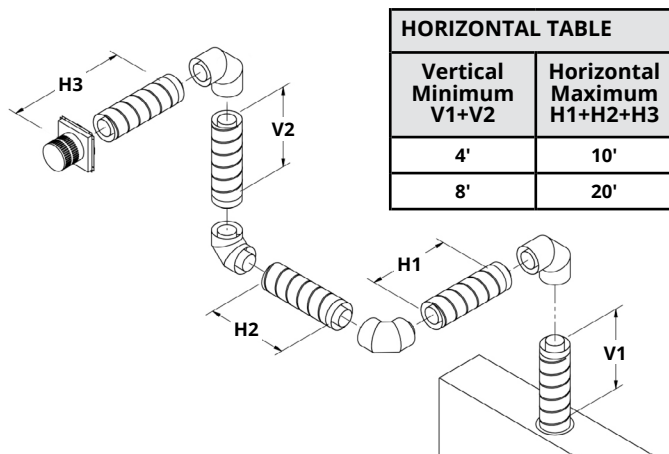

## Section 3-2: Installing a Roof Mounted Direct Vent Termination for 4"/7" (MVK1)

This section applies to installations where the direct vent termination will be roof mounted.

### Section 3-2-1: Venting Layout

Selection of components and details of venting lay out should adhere to the following guidelines:

- The maximum termination point is 34' above the fireplace (NOTE: if the maximum termination height is used, the flame pattern may be affected).
- The Vertical termination must be a minimum 2' higher than where the termination exits the roofing materials, (asphalt shingles, cedar shakes, etc). This distance should be measured from the high side of the roof slope where the flue flashing intersects the roofing materials.
- Termination location must be a minimum 6' from a mechanical air inlet.
- For a more detailed diagram of allowed termination locations, see Appendix A.
- A maximum of two offsets (each offset is made up of 2-90° bends) may be made for vertical vent runs. (2 45° bends are equivalent to 1 90°)
- Firestops must be installed as required by National & local codes.
- Ensure all horizontal runs are supported with a minimum of 3 supports per 10' of venting.
- Install all roof flashing and storm collars as shown.

#### Roof mounted terminations

The following details are some possible configurations for roof mounted terminations. See below.

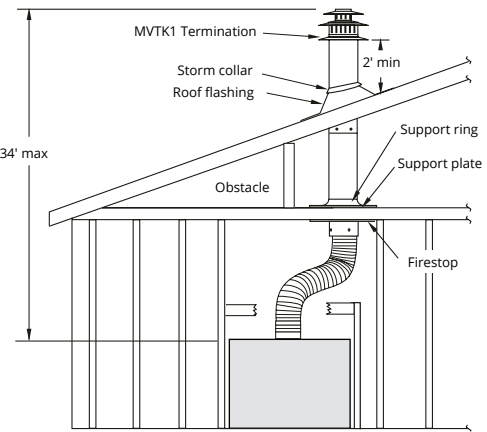

Figure 6.b Top vent, roof mounted with 1 offset (1 offset= two 90° bends).

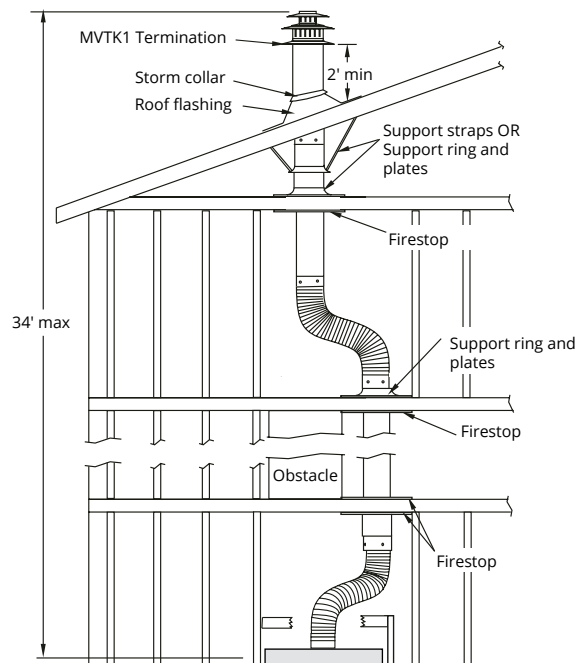

Figure 6.c Top vent, roof mounted with 2 offsets (1 offset= two 90° bends).

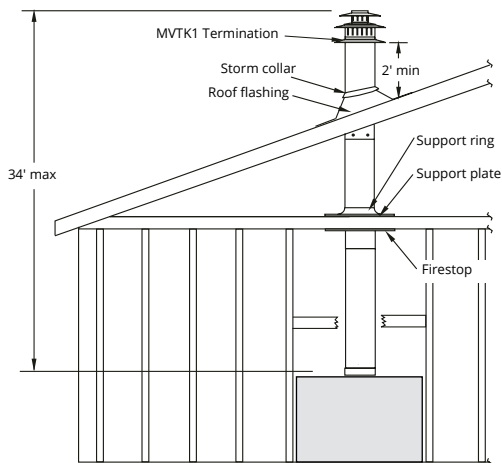

Figure 6. Top vent, roof mounted termination with no offset in vent run.

## Section 3-3: Installing a Wall Mounted Termination 4"/7"

This section applies to installations where the direct vent termination will be wall mounted. **NOTE:** If subject to a highly corrosive environment i.e. Seaside, Montigo recommends using Stainless Steel Termination.

### Installation of termination with built in frame

A termination with a built-in frame is installed during framing of a structure.

1. Frame the termination opening to 11" x 11".
2. Install exterior sheathing to the structure framing.
3. Fasten the termination to the sheathing using a minimum of 4 screws.

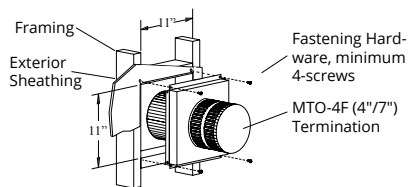

Figure 7. Installing a MTO4-F termination.

### Installation of termination frame at time of framing

Terminations with a MSR frame allow the installation of the frame prior to installation of the termination.

1. Frame the termination opening to 12" x 12".
2. Secure the MSR Frame to the exterior sheathing of the structure.
3. Fasten the termination to the MSR Frame using a minimum of 4 screws.

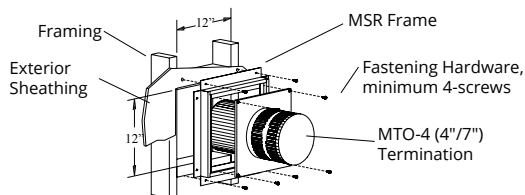

Figure 7.b Installing a PTO termination with the MSR frame.

### Installation of termination frame at time of framing in masonry

Terminations with a BSR frame allow the installation of the frame in masonry prior to the installation of the termination

1. Frame the BSR opening to 12" x 12".
2. Secure the BSR Frame to the exterior sheathing of the structure.
3. Fasten the termination to the BSR Frame using a minimum of 4 screws.

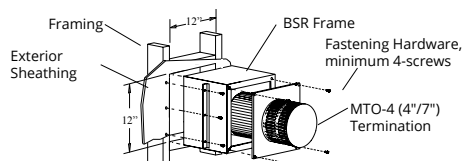

Figure 7.c Installing a MTO termination with the BSR frame.

### Installation of termination from inside structure

A Termination with a MOSR Frame is installed from the inside of the structure. These are commonly used in high-rise construction.

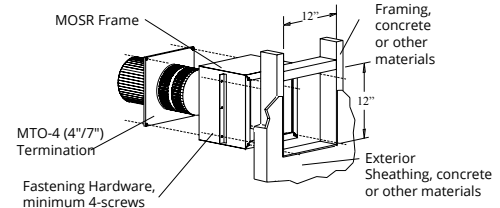

Figure 7.d Installing a MTO termination with MOSR frame.

1. Frame the MOSR opening to 12" x 12".
2. Fasten the MOSR frame to the interior side of the studs, concrete, or finished wall construction using a minimum of 4 screws.
3. Insert the termination into the MOSR frame as shown here, (from the inside) and attach to the MOSR by installing a min. quantity of 4 bolts into the threaded nuts on the MOSR Frame.

### Installation of a termination shield for vinyl siding

The VSS Termination shield is installed when the exterior of a structure is clad with Vinyl siding. It is placed directly above, and on-center with the termination.

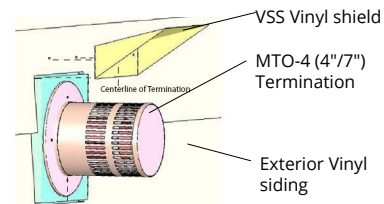

Figure 7.e Installing the VSS Vinyl Shield.

### Installing heat guards

Installing heat guards over terminations is recommended in installations where the termination is located within 7' feet above grade, or above a pedestrian walkway, and may be required by code in public areas.

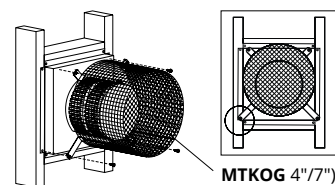

Figure 7.f Installing a MTO termination heat guard.

1. Ensure that the two long mounting brackets are facing the bottom of the termination (See inset). This will provide more heat protection at the top of the termination, where temperatures are highest.
2. Attach to the faceplate of the termination using four sheet metal screws.

## Section 3-3-2: Venting Components

The following components and associated Montigo part numbers are for installation of a roof or wall mounted termination. Use of non-Montigo approved parts will VOID the warranty and may impede operation of the fireplace.

<b>A - Termination</b>	MTO4 (3" Length) MTO4F (3" Length) MTO4FSS
<b>B - Frame Kits</b>	MSR (Stucco Frame) MOSR (Stucco Frame) BSR-4 (4" Brick Frame) BSR-6 (6" Brick Frame)
<b>C - Flex Sections</b>	MFL - 1 (12" f/f Section) MFL - 18 (18" f/f Section) MFL - 2 (24" f/f Section) MFL - 3 (36" f/f Section) MFL - 4 (48" f/f Section) MFL - 6 (72" f/f Section)
<b>D - Rigid Pipe</b>	MEXT - 1 (12" f/m Section) MEXT - 2 (24" f/m Section) MEXT - 3 (36" f/m Section) MEXT - 4 (48" f/m Section) MEXT - 6 (72" f/m Section)
<b>E - Rigid Pipe Extension</b>	EXT18 (18" f/f Section)
<b>F - Elbows</b>	MEL-90MM (m/m 90° Elbow) MEL-90FF (f/f 90° Elbow) MEL-90FM (f/m 90° Elbow) MEL-45FM (f/m 45° Elbow)
<b>G - Wall Penetration Kit</b>	MFVK01F
<b>H - Support Ring &amp; Plate</b>	MSPXT7
<b>I - Firestop</b>	FS7
<b>J - Roof Flashing</b>	MRF7 (1/12 - 7/12 pt.) MRF12 (7/12 - 12/12 pt.)
<b>K - Heat Shield</b>	RHS100
<b>L - Heat Guard</b>	MTKOG

## Connection and installation of the vent components should adhere to the following guidelines:

- Use any combination of rigid and flex pipe as required and in any orientation (Male connectors can face in any direction).
- Flex sections may be stretched up to 50% of their total length (e.g. a 24" section may be stretched to 36").
- Connect all vent sections using a minimum of three sheet metal screws on the outer pipe flue.
- Ensure the pipe ends male to female slide in a minimum of 1 1/2" of overlap.
- Ensure all horizontal runs are supported with a minimum of 3 supports per 10' of venting.
- When hanging/supporting venting, ensure that 1" clearance is maintained on sides and bottom of vent runs and 2" above horizontal vent runs to any combustible material.
- Rigid pipe may be cut less than half way from the **FEMALE END ONLY**.
- Ensure when cutting sections of rigid pipe to maintain integrity of internal supports.
- Flex pipe cannot be cut
- Place the springs, supplied with the pipe kit (flex only), between the outer and inner pipes to keep the pipes separate and avoid any possible hot spots.
- Montigo recommends the use of a flex section for the first section of venting connected directly to the fireplace, offering greater flexibility of installation and absorption of movement.
- Firestops must be installed as required by national & local codes.
- Montigo recommends that all exterior corners and joints be sealed with exterior caulking. However, we encourage you to consult your Building Envelope Engineer or Waterproofing Consultant for further recommendations.

### IMPORTANT:

Please refer to your Building Envelope Engineer or Waterproofing Consultant for a review of ALL penetrations through exterior walls or the roof.

## Section 3-3-2.2: Duravent DirectVent Pro 4" x 6<sup>5</sup>/<sub>8</sub>" Venting Components

The following Simpson Duravent venting components are approved for use with Montigo products. Please contact your local Montigo dealer for further information.

Component	Montigo Part Number	Simpson Duravent Part Number
<b>A - Termination</b>	MTO4 (3" Length) MTO4F (3" Length) MTO4FSS	Must use Montigo termination
<b>B - Frame Kits</b>	MSR (Stucco Frame) MOSR (Stucco Frame) BSR-4 (4" Brick Frame) BSR-6 (6" Brick Frame)	Must use Montigo termination
<b>C - Flex Sections</b>	MFL - 1 (12" f/f Connectors) MFL - 18 (18" f/f Section) MFL - 2 (24" f/f Section) MFL - 3 (36" f/f Section) MFL - 4 (48" f/f Section) MFL - 6 (72" f/f Section)	46DVA-48FF (48" F/F Section)  46DVA-120FF (120" f/f Section)
<b>D - Rigid Pipe</b>	MEXT - 1 (12" f/m Section)  MEXT - 2 (24" f/m Section) MEXT - 3 (36" f/m Section) MEXT - 4 (48" f/m Section)  MEXT - 6 (72" f/m Section)	46DVA-06 (6" Section) 46DVA-09 (9" Section) 46DVA-12 (12" Section) 46DVA-18 (18" Section) 46DVA-24 (24" Section) 46DVA-36 (36" Section) 46DVA-48 (48" Section) 46DVA-60 (60" Section)
<b>E - Rigid Pipe Extension</b>	EXT18 (18" f/f Section)	46DVA-08A (8 <sup>1</sup> / <sub>2</sub> " Length) 46DVA-16A (16" Length)
<b>F - Elbows</b>	MEL-90MM (m/m 90° Elbow) MEL-90FF ( f/f 90° Elbow) MEL-90FM ( f/m 90° Elbow) MEL-45FM ( f/m 45° Elbow)	46DVA-E30 (30° Elbow) 46DVA-E45 (45° Elbow) 46DVA-E60 (60° Elbow) 46DVA-E90 (90° Elbow)
<b>G - Wall Penetration Kit</b>	MFVK01F	
<b>H - Support Ring &amp; Plate</b>	MSPXT7	46DVA-ES (Elbow strap) 46DVA-RS (Roof support)
<b>I - Firestop</b>	FS7	46DVA-WFS 46DVA-WFS2
<b>J - Roof Flashing</b>	MRF7 (1/12 - 7/12 pt.) MRF12 (7/12 - 12/12 pt.)	46DVA-F6(DS) (0/12-6/12 pt.) 46DVA-F12(DS) (6/12-12/12 pt.) 46DVA-FF (Flat Roof Flashing)
<b>K - Heat Shield</b>	RHS100	46DVA-WT 46DVA-WTS
<b>L - Heat Guard</b>	MTKOG	

**46DVA-AD-M2 Termination Adapter**



**46DVA-AD-M1 Mounting Adapter**

### NOTICE

DirectVent Pro 4" x 6<sup>5</sup>/<sub>8</sub>" requires the 46DVA-AD-M1 Mounting Adapter to reduce from native 4<sup>1</sup>/<sub>7</sub>" size. A Montigo 4<sup>1</sup>/<sub>7</sub>" termination must be used by installing the 46DVA-AD-M2 Termination Adapter

## Section 3-3-3: Heat Shields 4"/7"

### Installing a Wall Mounted RHS7 heat shield

The RHS7 Heat shield CANNOT be used WITHIN 36" horizontal or 60" vertically of the fireplace. For applications within these dimensions the RHS100 Heat Shield MUST be used.

To install the RHS7, frame an opening in combustible construction, Figure 15.a below. Slide the Heat shield in place over the vent pipe which attaches to the fireplace. After the fireplace and vent pipe has been installed, clearances should match the dimensions in Figure 15.a

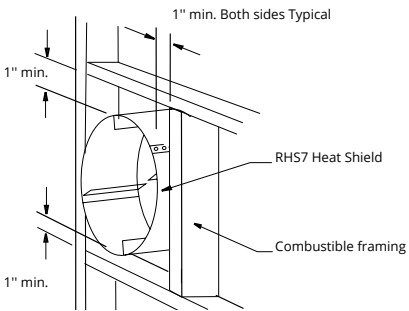

**Figure 15.a** RHS7 Installation. (Install by sliding over vent pipe where it passes through the combustible construction).

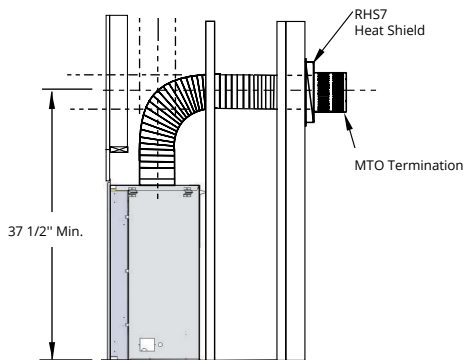

**Figure 15.b** RHS7 Installation. (Minimum requirements).

### Installing a Wall Mounted RHS100 Heat shield

The RHS100 Heat shield MUST be used where the RHS7 Termination CANNOT be used. Use the RHS100 within 36" horizontal or 60" vertical.

To install the RHS100, Slide the Inner Section over the vent pipe that will connect to the fireplace. Fasten the vent pipe to the back of the fireplace with a Min. of three sheet metal screws.

Next, slide the RHS100 outer section from the outside of the structure. To complete the installation fasten the Heat Shield Outer Section & Termination frame to the structure.

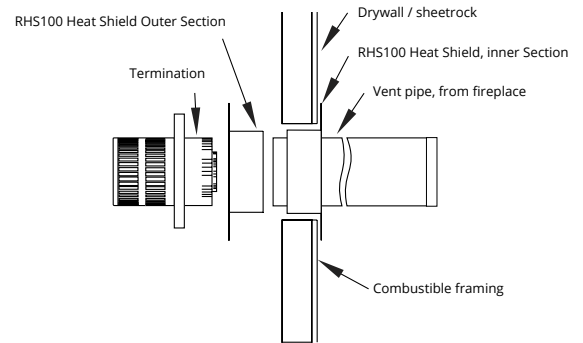

**Figure 15.c** RHS100 Installation. (Install by sliding Outer Section over vent pipe where it passes through the combustible construction).

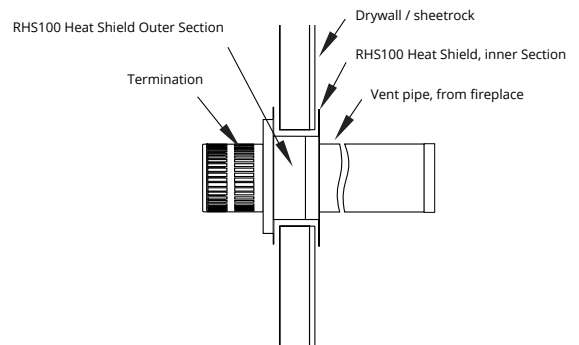

**Figure 15.d** Heat Shield. After sliding the outer section in place.

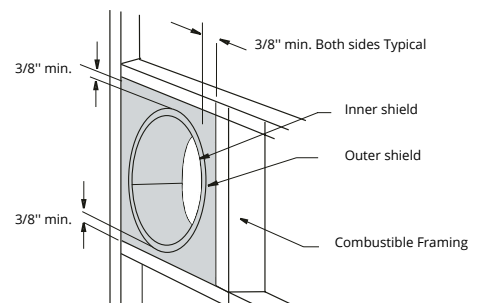

**Figure 15.e** RHS100 Installation

## Section 4: Wiring

### DRL\*\*13 (N/L) I Wiring Diagram

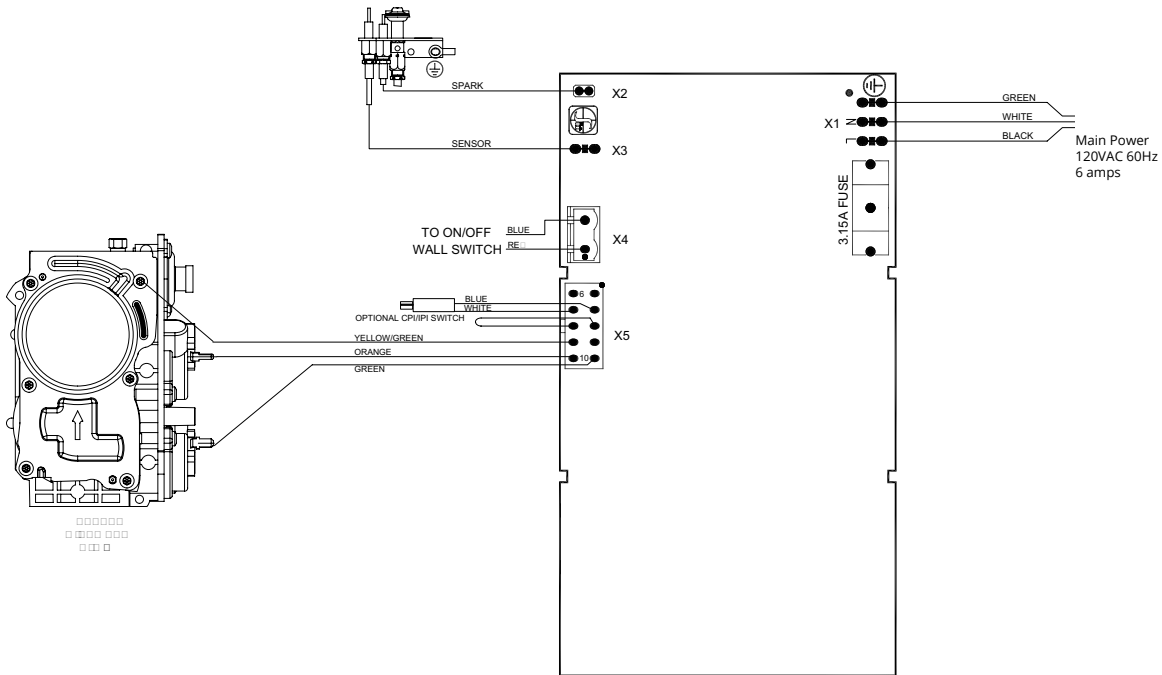

MODEL
DRL3613*1
DRL4813*1

Figure 15. Wiring diagram for DRL3613NI with SIT Proflame Electronic Ignition

### Installation of the wall switch

Montigo supplies 15' of low voltage wire to be plugged into the control board. Connect to a standard single pole ON/OFF switch to the location of your choice. You may extend these wires up to 30' in length with a wire of equal quality.

Installations in Canada must be electrically grounded in accordance with CSA C22.1 Canadian Electrical Code Part 1 and/or Local Codes.

Installations in the USA must be electrically grounded in accordance with local codes or, in the absence of local codes, with the National Electrical Code, ANSI/NFPA 70.

Optional remote control available through your Montigo Dealer.



## DRL\*\*13 (N/L) I-2 Wiring Diagram

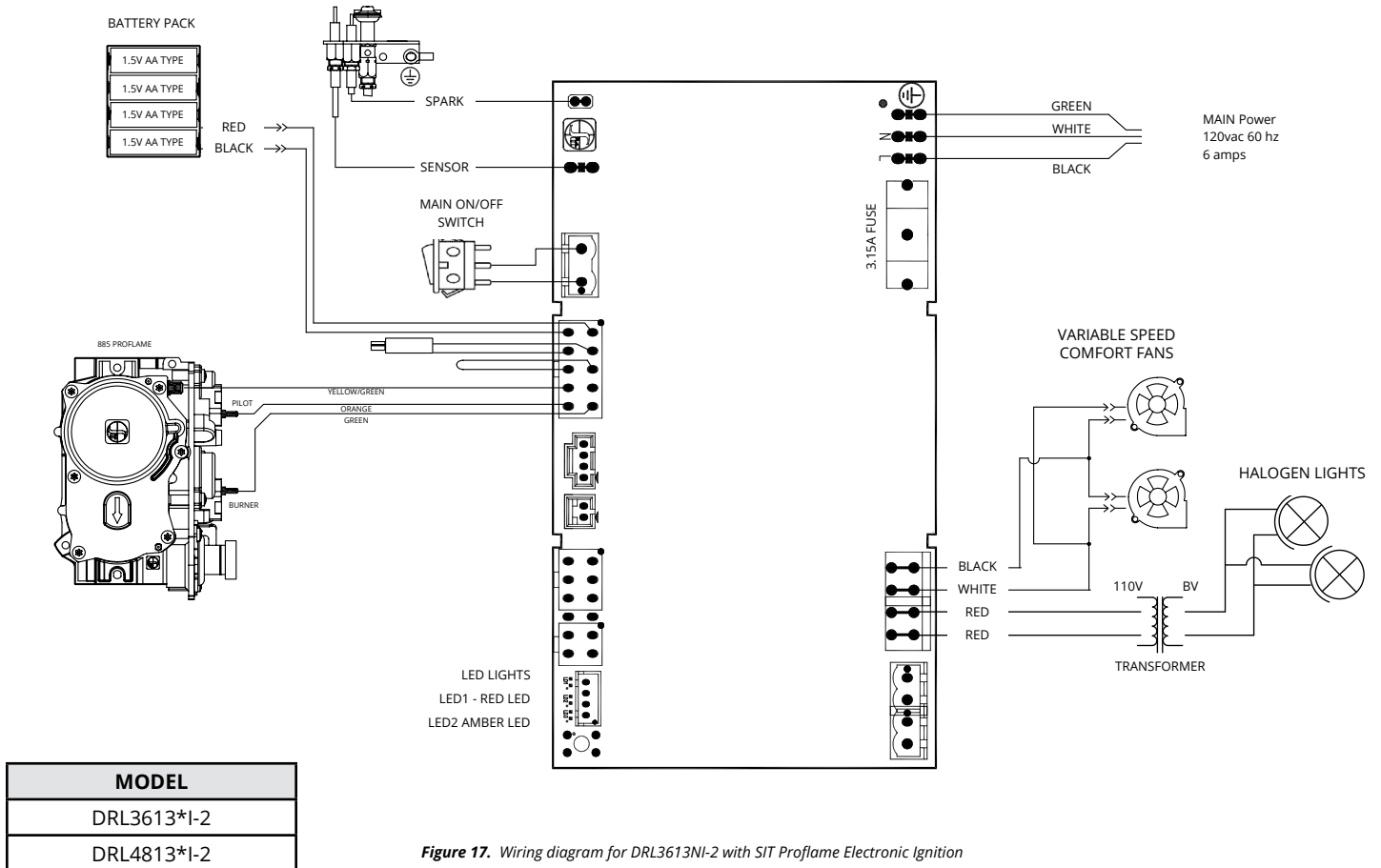

Figure 17. Wiring diagram for DRL3613NI-2 with SIT Proflame Electronic Ignition

## Installation of Electrical Supply

Installations in Canada must be electrically grounded in accordance with CSA C22.1 Canadian Electrical Code Part 1 and/or Local Codes.

Installations in the USA must be grounded in accordance with local codes or, in the absence of local codes, with the National Electrical Code, ANSI/NFPA 70.

NOTE: If any of the original wire supplied with the appliance is replaced, it must be replaced with the same type, or its equivalent.

## Section 5: Installing the gas line

### Fuel Type

- Verify that your fireplace is compatible with your available gas type. (Natural Gas or Propane shown by "N" or "L" in your model number)
- If gas type is not compatible, contact your local Montigo dealer.

### Gas Pressure

- Optimum appliance performance requires proper input pressures.
- Gas line sizing requirements will be determined in ANSI Z223.1/NFPA 54 National Fuel Gas Code in the USA and CAN/CGA B149.1 in Canada.

#### Pressure requirements (during operation):

PRESSURE REQUIREMENTS		
Gas Pressure	Natural Gas	Propane
Minimum inlet pressure	5.5in. w.c.	13in. w.c.
Manifold pressure	3.5in. w.c.	10in. w.c.

Figure 20. Pressure Requirements

- The manifold outlet pressure is set from the factory to the appropriate pressure but should be verified.
- To check pressures, control valves have a provision to remove a 1/8" N.P.T. plug to be fitted with a hose barb.
- Montigo requires a service shut off valve be located in an accessible location to isolate the gas supply.
- Only install gas shut-off valves approved for use by the state, province, or other governing body in which the fireplace is being installed.

### Section 5-3: GAS CONNECTION

- See Figure 20.b or 20.c for location of gas line access.
- Flexible gas connectors must not exceed 2 feet in length, unless allowable within local regulations.
- Connect incoming gas line to the 1/2" or 3/8" gas inlet port.
- Check appliance connection, valve and valve train under normal operating pressure with a commercially available leak check solution.

**DO NOT USE A FLAME OF ANY KIND TO TEST FOR LEAKS.**

## NOTICE

When pressure testing the fireplace, gas line, and input system follow the appropriate local codes for your area. DO NOT connect the fireplace to pressures in excess of **0.5 psig. (14" w.c.)** This will damage the gas control valve.

## ⚠ DANGER

After gas line is connected, each appliance connection, valve and valve train **MUST** be checked while under normal operating pressure with either a Liquid Solution, or Leak Detection Device, to locate any source of leak. Tighten any areas where bubbling appears or a leak is detected until bubbling stops completely or leak is no longer detected. **DO NOT** use a flame of any kind to test for leaks. A fire or explosion will occur, causing serious injury, property damage or death.

## ⚠ WARNING

An inspection of the explosion relief flappers and door **MUST** be made prior to lighting the fireplace. A faulty seal on the door gasket and/or explosion ports will result in products of combustion leaking into the living space and may result in carbon monoxide poisoning.

### Finishing Safety Zone

Take special care when finishing underneath the fireplace door due to the location of the gas valve and control board. Any screw can possibly puncture one of these components resulting in either a non operational unit or worse, a gas leak.

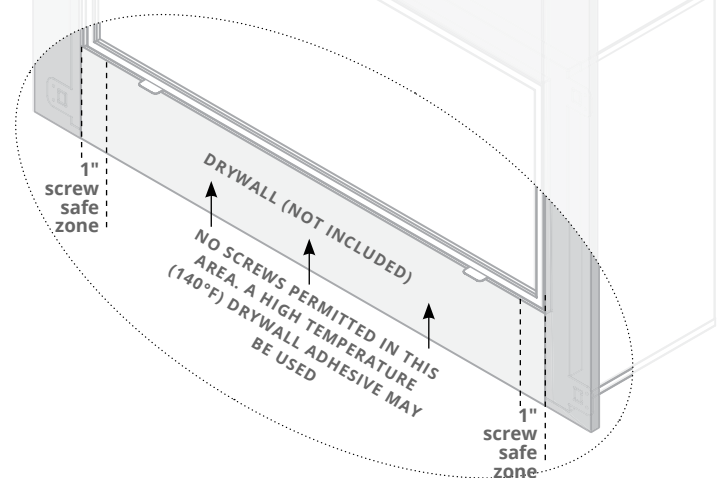

## ⚠ WARNING

Not following the safe screw area may result in puncture of the control board or the gas valve/line.

## Section 6: Finishing

### Finishing Around the Fireplace

#### Mantel Projections

When sizing the finish material for your fireplace, it is important to remember the following: THE OPENING MUST NOT BE OBSTRUCTED IN ANYWAY - to do so restricts the air supply for the control compartments and heat exchanger it also prevents access for servicing controls.

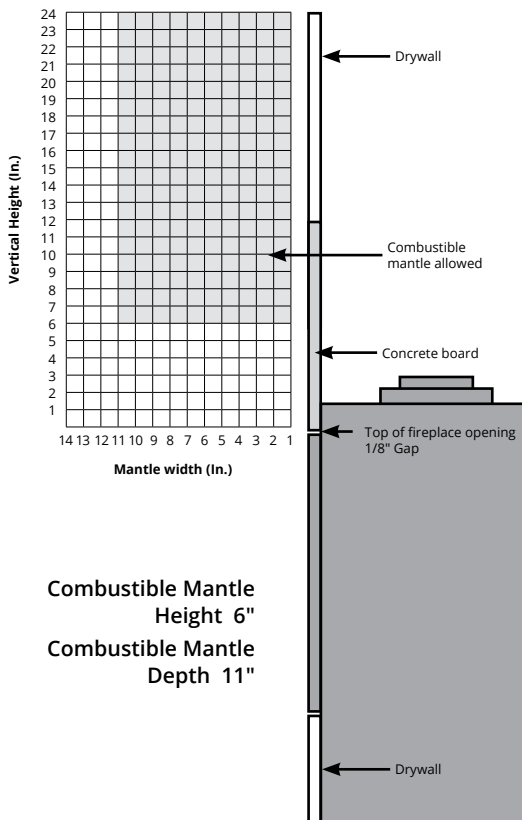

Figure 19. Combustible mantles and facings. (Not to scale)

### CAUTION

We recommend careful consideration be given to the effects of elevated mantel temperatures which may be in excess of product design, for example: candles, plastic or pictures. This can cause melting, deformation, discoloration or premature failure of T.V. radio, and other electronic components.

### WARNING

Fireplaces cannot be recessed into a wall cavity.

### Sidewall clearances

Side wall clearances are 4". Combustible surrounds may be installed with 4" clearance to the side of the fireplace as shown.

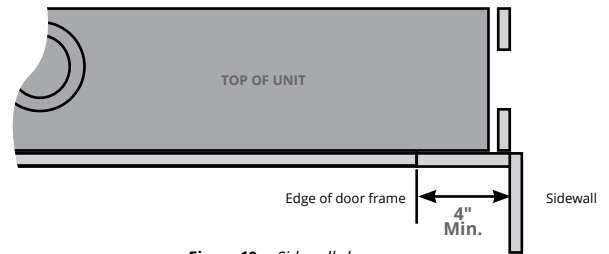

Figure 19.c Sidewall clearances

### NOTICE

4" clearance in sidewall drawing does not apply to recession, unit cannot be recessed into a wall.

### Cement Board Install

Install the supplied non-combustible cement board to overlap the new horizontal & vertical 2 x 4's, place the non-combustible wall board above the fireplace throat, allowing 1/8" clearance from the rim above the fireplace opening. Pre-drill the board with 1/8" drill bit and secure to framing with nails, use flat head sheet metal screws to fasten the board to the metal header.

#### SINGLE SIDED

Top (Qty 1)

Sides (Qty 2)

Cut standard Gyproc / Drywall board to complete the installation of the surround. Fit the edge of the board to the rim around the fireplace opening. Fasten the board in place using standard drywall screws.

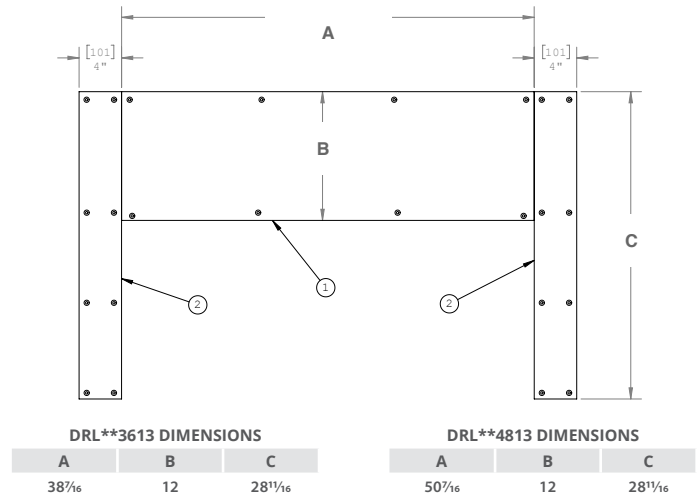

Figure 28. Supplied non-combustible cement board dimensions

## Section 8: Removing & Installing the Screen / Door

### Removing the Screen

Follow the steps below to remove, or install the fireplace screen and door. Before beginning any screen or glass removal, make sure that the unit has not been in operation and that it is at room temperature.

**Step 1:** Locate the three tabs at the base of the screen.

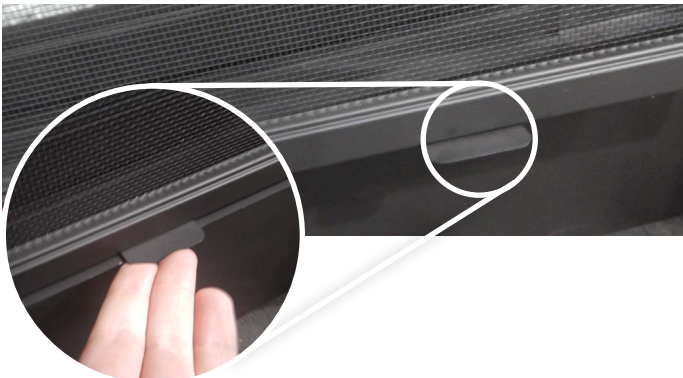

Figure 20. Locate the three tabs at the base of the screen

**Step 2:** Lift out the Retaining Tabs and screen.

Pull the bottom of the screen outward, then slide out the screen from the frame.

Store in a safe place. The Screen is very fragile and can be easily torn, dented or deformed. Refer to Figure 20.b below.



Figure 20.b Lift out the Retaining Tabs and screen

### Reinstalling the Screen

Follow the two previous steps to re-install the fireplace window.

#### NOTICE

Any safety screen, guard, or barrier removed for servicing an appliance, must be replaced prior to operating the appliance

### Removing the door

The door is removed in a few simple steps. Follow these steps below to unlatch the door buckles and remove the door.

#### STEP 1:

Remove lower valve blinds and screen setting bar.

#### STEP 2:

Ensure the tool is firmly in the lower end of the slot, (as shown), Then pull toward you, door will unlatch, repeat for other buckles.



Figure 21.d Pull door latches

#### STEP 3:

Pull the top of the door towards you, then lift the door up and out of the fireplace frame.

Store in a safe place.



Figure 21.e Lift the door

### Reinstalling the door

NOTE: Make sure the top and base of the door slips into the narrow channel in the frame to ensure proper placement.

#### STEP 1:

Line up the notch of the bottom of the door with the tab on the door channel.



Figure 21.b Installing the door

#### STEP 2:

Buckles are locked into place by pulling out and up, latch will pop into place.

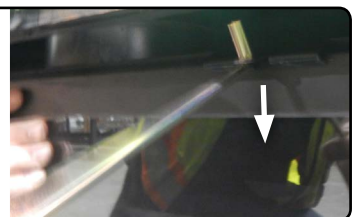

Figure 21.d Pull door latches

## Propane Conversion

To convert the DelRay from Natural Gas to Propane, install the GCA010 conversion kit. The unit must be disconnected from any gas supply, disconnected from any electrical supply and batteries and removed from any installation cavity.

### Tools required

- 1). Torx T20 Screw Driver Bit
- 2). 1/2" Socket Driver
- 3). 5/32" Allen Key
- 4). Needle Nose Pliers or Small Flat Head Screw Driver
- 2). 1/4" Socket Driver

### Parts included

- 1). Propane burner orifice
- 2). Propane pilot orifice
- 3). Propane valve control (with mounting screws)
- 4). Valve conversion label
- 5). Conversion plate label
- 6). Conversion technician identifying label

**For input rating, manifold pressure and orifice size, refer to sample rating plate**

### WARNING

This conversion kit shall be installed by a qualified gas fitter in accordance with the manufacturer's instructions and all applicable codes and requirements of the authority having jurisdiction. If the information in these instructions is not followed exactly, a fire, explosion or production of carbon monoxide may result causing property damage, personal injury or loss of life. The qualified service agency is responsible for the proper installation of this kit. The installation is not proper and complete until the operation of the converted appliance is checked as specified in the manufacturer's instructions supplied with the kit.

### CAUTION

The gas supply shall be shut off prior to disconnecting the electrical power, before proceeding with the conversion.

1. Shut off gas supply.

2. Remove the 2 screws securing the pilot cover to the media tray. Remove 2 screws on burner clamp.

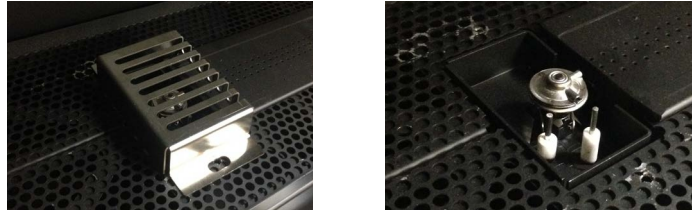

Figure 13. Removal of pilot cover

3. Burner can now be removed.



Figure 13.b Loosening the venturi

4. Use 1/2" Socket Driver to loosen off the NG gas orifice, replace with Propane orifice as included in package. #1.15mm

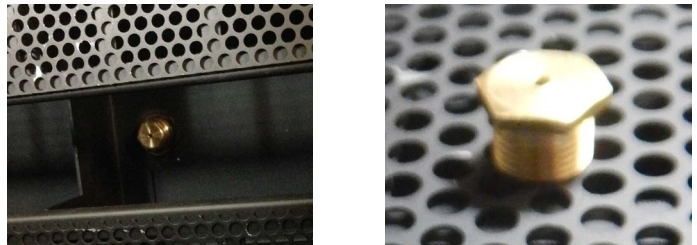

Figure 13.c Removing the orifice

5. Remove natural gas mixer sleeve from burner. Reinstall burner

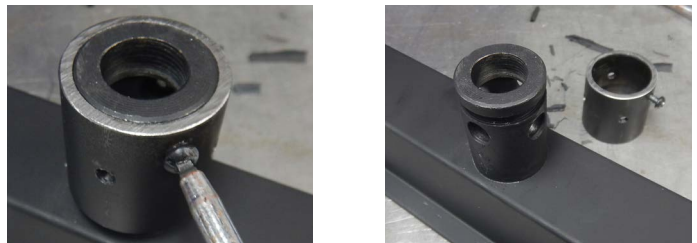

Figure 13.c Removing the orifice

6. Use screwdriver to carefully detach spring clip from the pilot hood. (Spring clip will be reused)



**Figure 13.d** Removing the spring clip

7. Remove pilot hood, then use allen key to remove pilot orifice.

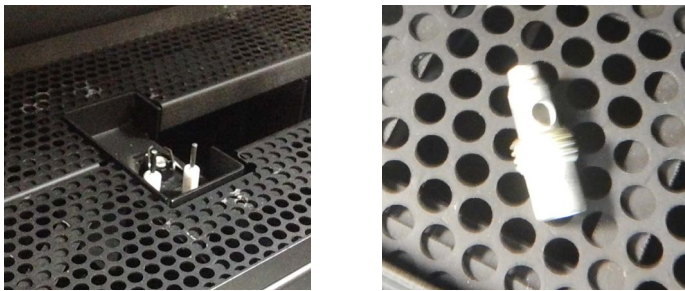

**Figure 13.e** Removing the pilot hood, orifice

8. Insert Propane pilot orifice. Reassemble pilot assembly and hood.

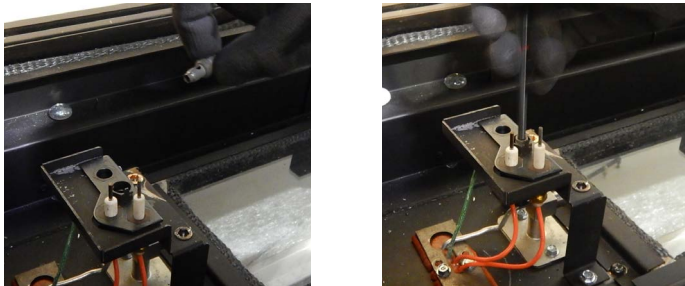
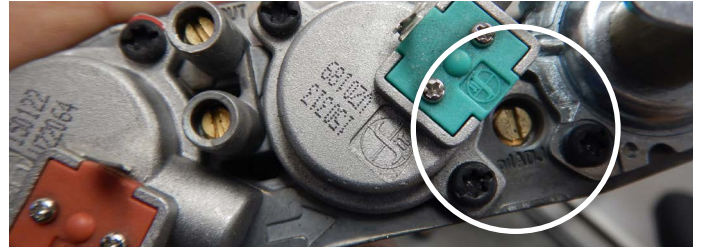

**Figure 13.f** Insert propane orifice, reassemble burner

9. See regulator instructions for guide on converting the pressure regulator gasket.



10. The pilot size can be adjusted using a flathead screwdriver to adjust "pilADJ" screw shown



**Figure 13.g** Adjust pilot size

11. The manifold and inlet pressure can be verified by using a manometer and a 1/8" rubber hose attached to the valve ports shown here (top is manifold, bottom is inlet) Use a soap-based leak testing solution on the valve regulator while the unit is operating to check for any leaks

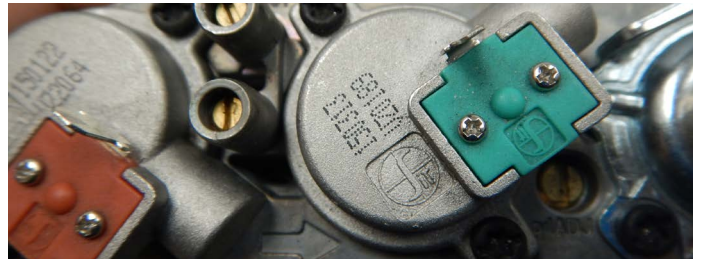

**Figure 13.h** Adjust pressure ports

12. Fill out required information on Propane conversion gas fitter sign off label, attach to reverse side of rating plate. Attach Rating plate conversion label to rating plate label. Place Valve conversion label on valve face.

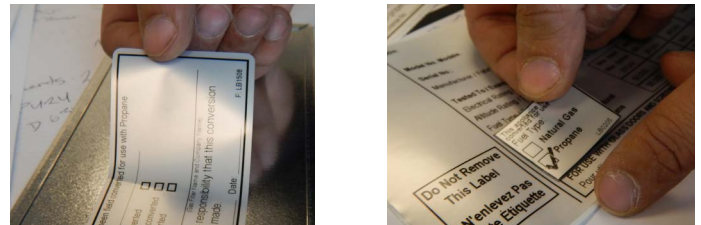

**Figure 13.i** Label reverse rating plate



**Figure 13.k** Conversion label on valve

## Section 9: Installing the Accessories

### Installing the Fireglass or Optional Glass Media

The unit is supplied with fireglass. Optional fireglass may be purchased from the dealer. Remove the Door as shown in the previous Instruction. Once the glass door is removed place the firestones randomly across the pan and the burners as described in Figure 24 to 24.b

Note: Only cover the burner with one layer of firestones or fireglass.



Figure 24.b Completed firestone installation

### DelRay 36" Optional Log Kit Installation

The Fireplace has the option of installing a drift wood log set. Once the base media of fireglass, firestones, or speckled stones has been placed the log set can be installed. Ensure logs are securely placed and will not tip or fall.

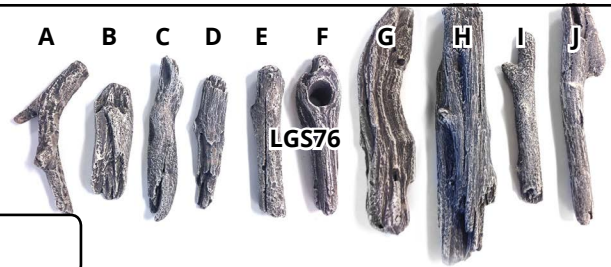

#### Propane Driftwood Layout

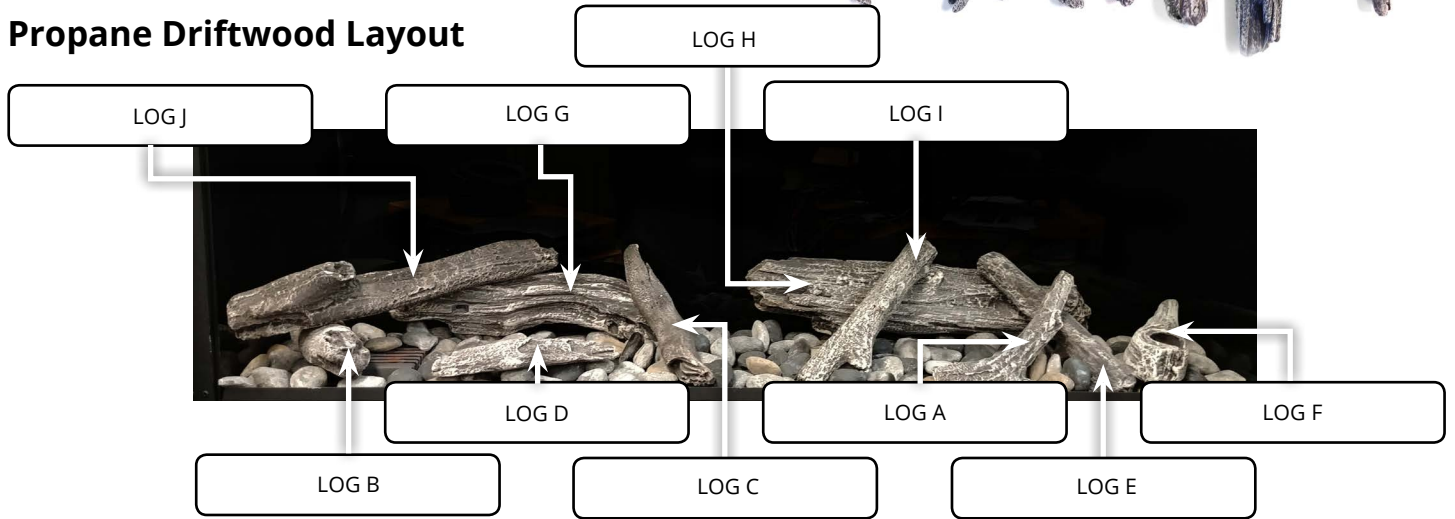

#### Natural Gas Driftwood Layout

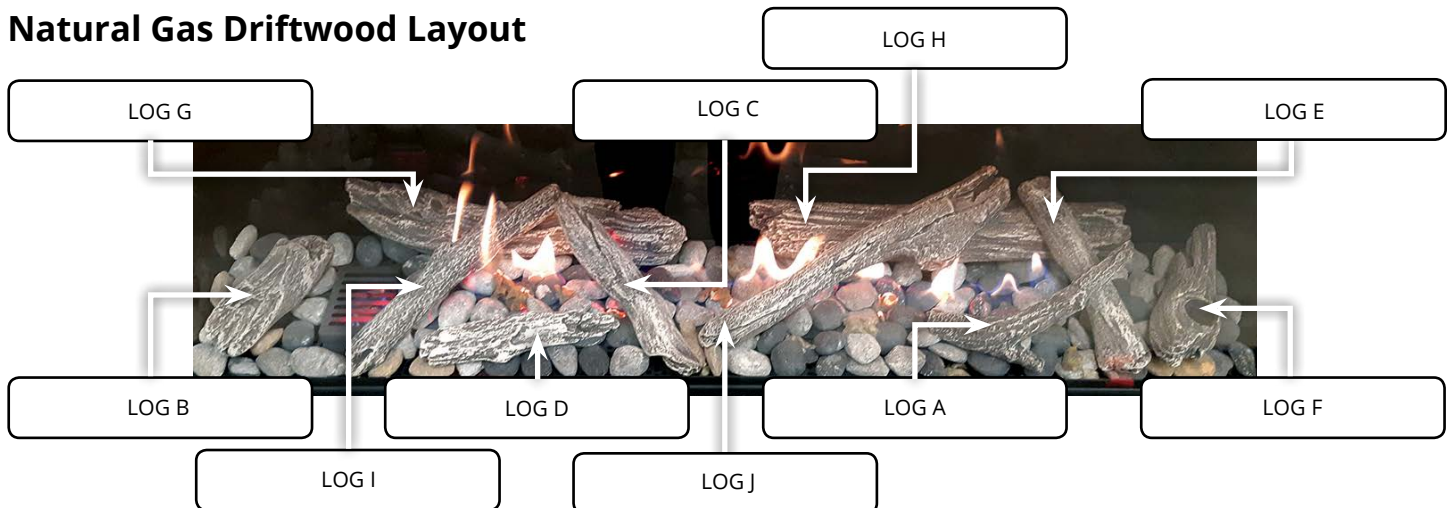

## DelRay 48" Optional Log Kit Installation

The Fireplace has the option of installing a drift wood log set. Once the base media of fireglass, firestones, or speckled stones has been placed the log set can be installed. Ensure logs are securely placed and will not tip or fall.

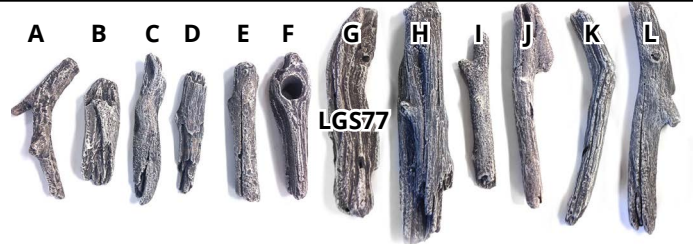

### Propane Driftwood Layout

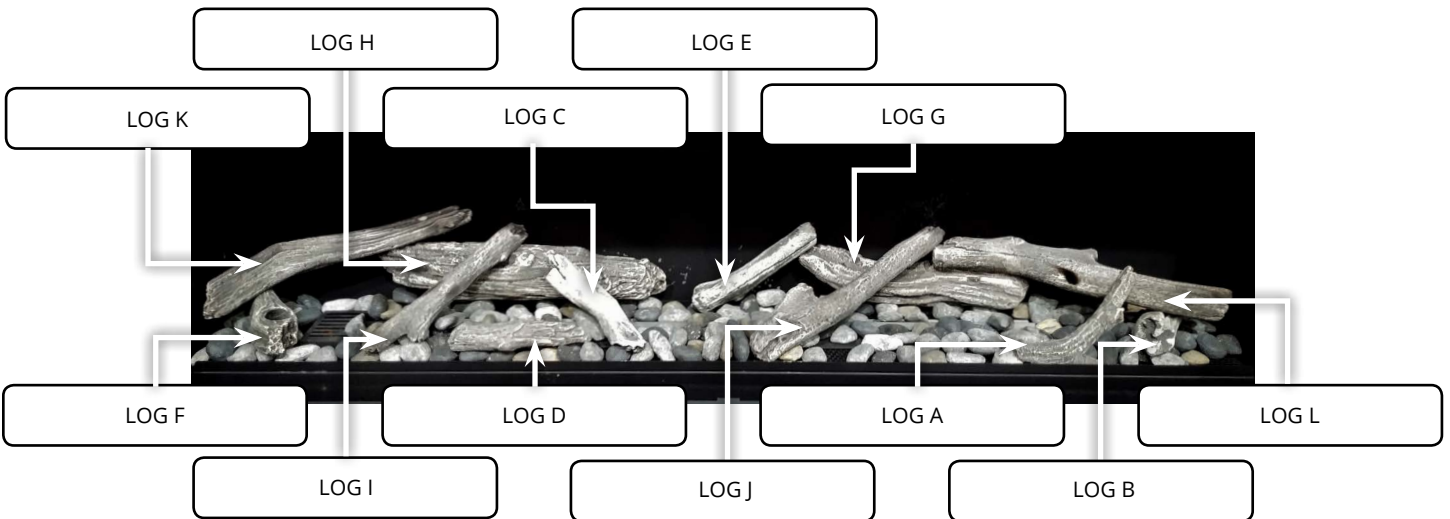

### Natural Gas Driftwood Layout

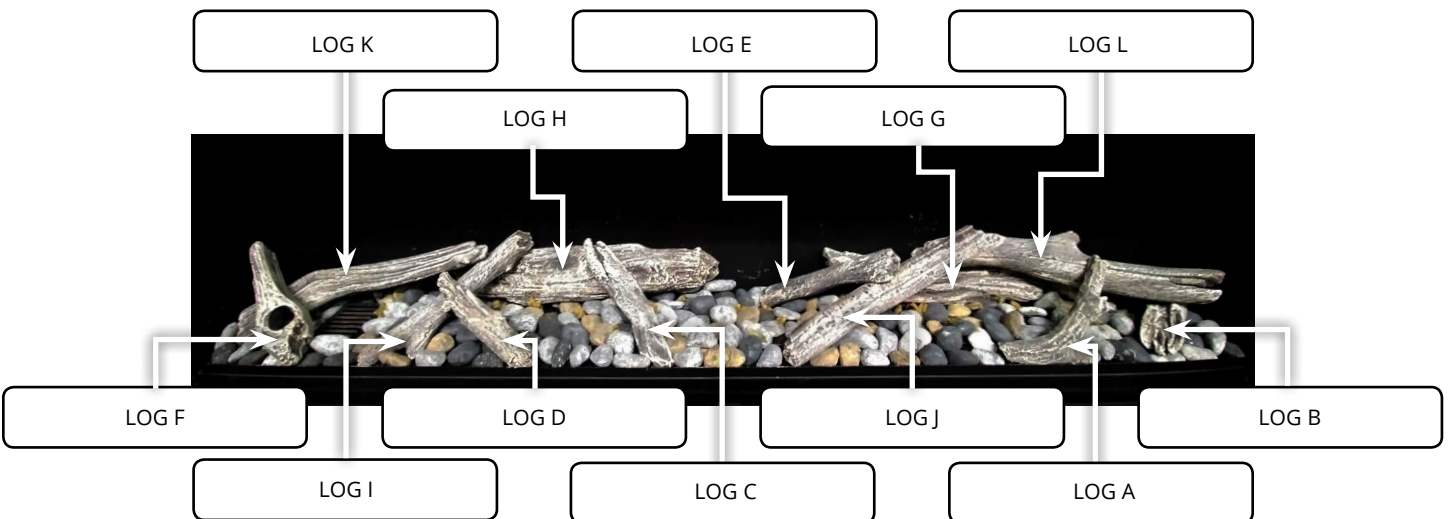



## FOR YOUR SAFETY - READ BEFORE LIGHTING:

DANGER



**HOT GLASS WILL CAUSE BURNS.**

**DO NOT TOUCH GLASS UNTIL COOLED.**

**NEVER ALLOW CHILDREN TO TOUCH GLASS.**

A barrier designed to reduce the risk of burns from the hot viewing glass is provided with this appliance and shall be installed for the protection of children and other at-risk individuals.

**WARNING: If the information in these instructions is not followed exactly, a fire or explosion may result causing property damage, personal injury or death.**

**WARNING/ CAUTION: Hot while in operation. Do not touch. Severe burns may result. Keep children, clothing, furniture, gasoline and other liquids having flammable vapours away.**

**See installation and operating instructions accompanying this appliance for more information.**

A. This appliance is equipped with an ignition system that lights the pilot burner automatically. **Do not attempt to light the pilot by hand.**

B. **BEFORE LIGHTING** smell all around the appliance area for gas. Be sure to smell next to the floor because some gas is heavier than air and will settle on the floor.

**What To Do If You Smell Gas:**

- Do not try to light any appliance.
- Do not touch any electrical switch; do not use any phone in your building.

- Immediately call your gas supplier from a neighbour's phone. Follow the gas supplier's instructions.

- If you cannot reach your gas supplier, call the Fire Department.

C. Use only your hand to operate gas control. Never use tools. If the control does not function, don't try to repair it, call a qualified service technician. Force or attempt to repair may result in a fire or explosion.

D. Do not use this appliance if any part has been under water. Immediately call a qualified service technician to inspect the appliance and to replace any part of the control system, and any gas control which has been under water.

## LIGHTING INSTRUCTIONS:

1. **STOP!** Read the safety information above on this label.
2. Turn "ON" manual "ON/OFF" switch. (If available)
3. Turn Incoming gas shut off valve to the "ON" position.
4. Wait 5 minutes to clear out any gas. If you smell gas, **STOP!** Follow "B" in the safety information above on this label. If you don't smell gas, go to the next step.
5. Turn fireplace "ON" using wall switch or remote control.
6. If the Fireplace does not light, the System will cycle through two trials, (one minute audible clicking, thirty seconds of silence, and then another one minute of audible clicking). If the system locks out due to inadequate gas flow, refer to "Troubleshooting" in instruction guide.
7. After completion of the information in the Troubleshooting section, Repeat step 5.
8. If the system will not function correctly, follow the instructions "To Turn Off Gas To Appliance" and call your service technician or gas supplier.

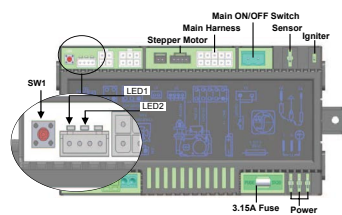

SW1 = Programming Button  
 LED1 = Red Diagnostic Light  
 LED2 = Amber Programming Remote Control Light  
 Typical Control Module shown

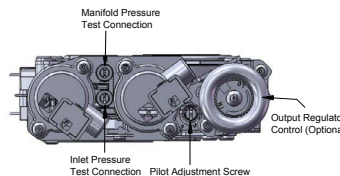

Gas Valve

## TO TURN OFF GAS TO APPLIANCE:

1. Turn off fireplace using wall switch or remote control.
2. Turn the incoming gas shut off valve to "Off".

P/N LB176-060614

## Section 10: Cleaning and Maintenance

### General

- Have the fireplace and installation inspected yearly. The inspection must include, but is not limited to, the following:
  - A visual check of the entire vent system and termination, where accessible.
  - An inspection of the explosion relief flappers and the door gaskets to ensure a proper seal.
  - An inspection of the burner, vent run, and primary air openings.
  - An inspection of the gas valve, gas components, and pilot flame. For your convenience a 1/8" manifold pressure tap is supplied on the gas valve for a test gauge connection.
  - Inspection of all optional equipment; fans, thermostats, remote control lights, etc.
- For Natural Gas this appliance requires a minimum inlet pressure of 5.5" W.C. and a manifold pressure of 3.5" W.C.
- For Propane Gas this appliance requires a minimum inlet pressure of 11" W.C. and a manifold pressure of 10" W.C.
- Always keep the fireplace area clear and free of combustibile materials, as well as gasoline and other flammable vapors and liquids.
- Do not use this appliance if any part has been under water. Immediately call a qualified service technician to inspect the appliance and to replace any part of the control system and any gas control which has been under water.
- Inspection of glass doors and screen for damage and proper installation.

### Cleaning

When the fireplace is first activated, there may be some smoke and a visible film may be left on the glass. This is a normal condition, and is the result of burning of protective coatings on new metal.

- Glass must be cleaned periodically to remove any film (which is a normal by-product of combustion) which may be visible. Film can easily be removed by removing the door. Handle the door carefully, and clean it with non-abrasive, non-ammonia based glass cleaners. One of the most effective products is Kel-Kem.
- During the initial firing, Silicone seals will "off gas", leaving a visual deposit of a white substance on combustion chamber walls. This can easily be removed using normal household products.
- Use a vacuum cleaner or whisk broom to keep the control compartment, burner, and firebox free from dust and lint.

### Pilot Burner Adjustment.

1. Locate Pilot Adjustment Screw. (See **figure 28**)
2. Adjust pilot screw to provide properly sized flame as shown.
3. After installing or servicing, leak test with a soap solution with main burner on. Coat pipe and tubing joints, gasket etc. with soap solution. Bubbles indicate leaks. Tighten any areas where the bubbles appear until the bubbling stops completely.

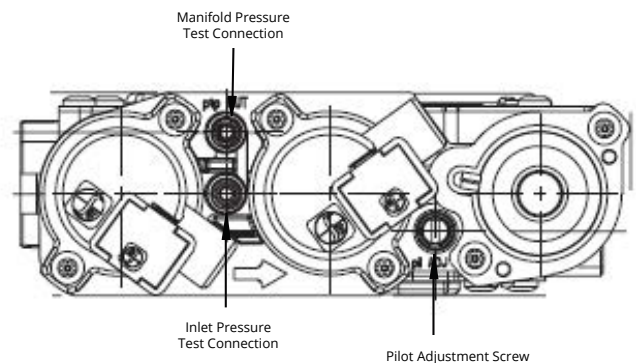

**Figure 28.** Pilot Adjustment on the SIT Proflame 2 gas valve.

## NOTICE

Do not use ammonia or abrasive cleaners on the glass, they will permanently etch the surface. Use an approved gas fireplace cleaner such as Kel-Kem or White off.

### **Annual inspection list for determining safe operation of a direct vent gas fireplace**

- 1) Inspect and operate the pressure relief mechanism to verify relief mechanisms are free from obstruction to operate.
- 2) Clean glass window with a suitable fireplace glass cleaner. Abrasive cleaners must not be used. Be careful not to scratch the glass when cleaning.
- 3) Inspect the operation of the flame safety system Pilot or Flame rectification device.
- 4) Inspect and ensure the lighting of the main burner occurs within 4 seconds of the main gas valve opening. Visual inspection should match that outlined in the appliance instruction manual. Inspect primary air openings for blockage.
- 5) Inspect condition of vent and vent terminal for sooting or obstruction and correct if present.
- 6) Vacuum and clean any debris in the firebox that is not supposed to be there.
- 7) Test and measure the flame failure response time of the flame safety system. It must de-energize the safety shutoff in no more than 30 seconds.
- 8) Check all accessible gas-carrying tubes, connections, pipes and other components for leaks.

## Troubleshooting

The following is a troubleshooting chart of possible problems:

PROBLEM	SOLUTION
Pilot Igniter won't spark	<ol style="list-style-type: none"> <li>1. Check the MAIN ON-OFF switch (typically located below the valve cover) and turn ON</li> <li>2. Ensure main power is ON or new batteries are installed in the remote control and backup battery pack (if available).</li> <li>3. Check the 3.15A fuse in the control box and replace if necessary</li> </ol>
Pilot Igniter sparking, but Pilot burner will not light	<ol style="list-style-type: none"> <li>1. Verify the Inlet and Manifold Gas Pressure are within acceptable limits</li> <li>2. Check all connections to gas valve</li> <li>3. Check connection to stepper motor (if available)</li> </ol>
Pilot lights, but Main burner will not Light	<ol style="list-style-type: none"> <li>1. Check and verify all wiring connections as per the wiring diagram.</li> <li>2. Verify the inlet and Manifold Pressure are within acceptable limits</li> </ol>
Pilot lights, but Main burner will not Light and igniter continues to spark	<ol style="list-style-type: none"> <li>1. Check the Pilot Flame Sensor Rod and clean with steel wool or similar.</li> <li>2. Check the Pilot hood and clean with steel wool if dirty.</li> <li>3. Adjust pilot flame using the pilot adjustment screw if the pilot flame is too long or too short (Flame should fully engulf the sensor rod and must be stable).</li> <li>4. Check and make sure the ground wire from the pilot is connected to the fireplace body.</li> </ol>

If your fireplace still does not operate correctly, consult your local Montigo dealer.

**All service and repairs should be performed by a qualified Technician.**

All spare parts, optional fans, and optional trim finishes are available from your local Montigo dealer.

## Direct Vent Outdoor Applications

Montigo Direct vent fireplaces are approved for use in protected outdoor applications with the approved guidelines listed. This applies to any outdoor rooms and patios. Do not use this guideline for vent free fireplaces.

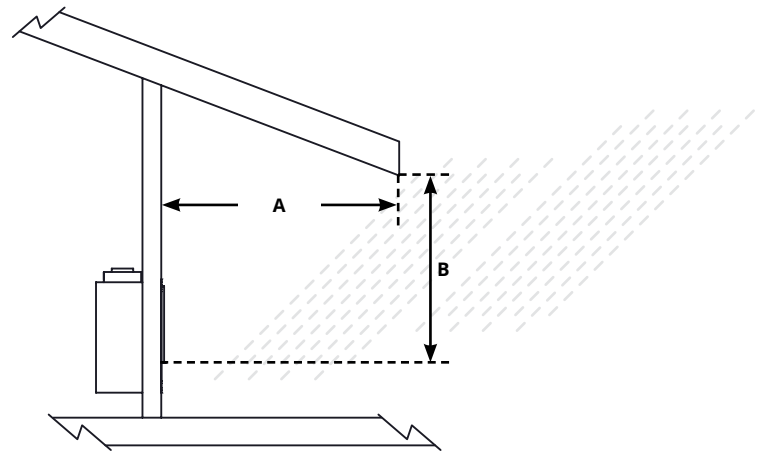

### Minimum overhang chart

The overhang depth (Shown as A) must be at least 50% of the overhang height (Shown as B). This is measured from the bottom of the fireplace doors finished edge to the overhang.

Example: If the roof height is 7' from the bottom edge of the fireplace door, then the overhang must be at least 3.5'

### Notes

- Indoor see-through models cannot be installed as indoor/outdoor fireplaces
- If the fireplace will be in contact with salt water, then an outdoor fireplace is recommended
- Follow all building codes, including those addressing fireplace penetration of an exterior building envelope
- Follow all product installation instructions; including clearances to framing and facing

## Appendix A: Venting Terminations

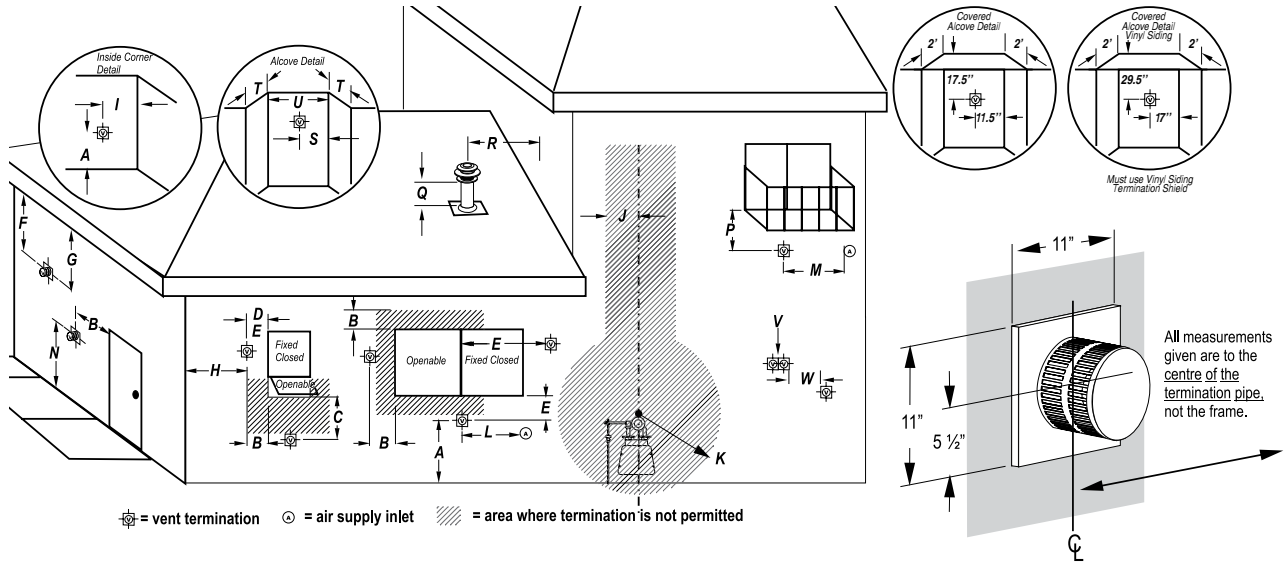

Location	Canada*	USA**
A clearance to the termination frame above grade, veranda, porch, deck, or balcony	12 inches	12 inches
B clearance to top of doors or operable windows	12 inches	12 inches
C clearance to sides or bottom of door or operable windows	12 inches	9 inches
D clearance to permanently closed window when installed with approved glass penetration termination	0	0
E clearance to permanently closed window Recommended to prevent condensation	16 inches	16 inches
F clearance to ventilated soffit located within a horizontal distance to 24 inches from centerline of termination	22 inches	22 inches
G clearance to unventilated soffit	30 inches to combustibles 16 inches to non-combustibles	30 inches to combustibles 16 inches to non-combustibles
H clearance to outside corner	9 inches	9 inches
I clearance to inside corner	12 inches	12 inches
J clearance to each side of the vertical centerline of a metre or regulatory assembly to a maximum vertical distance of 15ft	3 feet	3 feet
K clearance to service regulator vent outlet	3 feet	3 feet
L clearance to non mechanical air supply inlet to the building or combustion air inlet to other appliance for appliance <= 100,000 BTU/H (30 kW)	12 inches	12 inches
M clearance to forced air supply inlet	6 feet	3 feet above air inlet
N clearance above paved sidewalk or paved driveway located on public property	7 feet	7 feet
P clearance under veranda, porch, deck, or balcony	22 inches to combustibles 16 inches to non-combustibles	22 inches to combustibles 16 inches to non-combustibles
Q clearance above roof	2 feet	2 feet
R clearance to adjacent walls and neighboring buildings	2 feet	18 inches
S clearance from corner in recessed location	12 inches	12 inches
T Maximum depth of recessed location	4 feet	4 feet
U Maximum width for back wall of recessed location	2 feet	2 feet
V Horizontal clearance between two terminations that are level	0	0
W Horizontal clearance (centre to centre) between two terminations that are not level	18 inches	18 inches

Note 1: For N a vent shall not terminate directly above the sidewalk or paved driveway which is located between two single family dwellings and serve both dwelling.

Note 2: For P only permitted if veranda, porch, deck, or balcony is fully open on a minimum of two sides beneath the floor

Note 3: For J, K, and as specified in CGA B149 installation code. Local codes or regulations may vary.

\* Based on CGA B149.1 Natural Gas and Propane installation code. Local codes may vary, please check with local regulatory agency.

\*\* Based on ANSI Z223.1/NFPA 54 National Fuel Gas Code. Local codes may vary, please check with local regulatory agency.

## Appendix B: Warranty

### MONTIGO RESIDENTIAL WARRANTY PROGRAM

Canadian Heating Products Inc. and/or Montigo DelRay Corp (collectively referred to herein as "The Companies"), warrants the Montigo gas appliance (referred to herein as 'the appliance') to be free from defects in materials and workmanship at the time of manufacture. The gas appliance and related components are further subject to the terms and conditions set forth below.

**This warranty covers the following Montigo product series: Distinction, H, I, L, Linear P and PL, R, RP, Mahana and DelRay**

Component	Coverage Period	Labor Coverage
Firebox, heat exchanger	15 years	1 year
Main burner	15 years	1 year
Gas control valve and related control components (pilot assembly, spark electrode flame sensors, thermopile)	1 year	1 year
Electrical components (internal blowers, ignition control module, wiring, switches, remote control systems, blower control module, accent bulbs)	1 year	1 year
Firebox media (logset, glass beads, river rocks)	1 year	1 year
Glass (thermal breakage)	1 year	1 year
Plated, painted finishes (including interior reflective glass)*	1 year	1 year
Refractory lining	1 year	1 year
Mesh/Glass safety barriers	1 year	1 year
Power Vent Control box	1 year	1 year
Montigo Venting (excluding terminations)	15 years	1 year

\* Exterior painted surfaces exempt

### QUALIFICATIONS TO THE WARRANTY

This Warranty only covers gas appliances installed in the United States or Canada.

To receive the benefits of this warranty, the appliance must be purchased, installed and serviced annually by a dealer authorized by The Companies for the warranty to be valid.

The gas appliance must be installed by a licensed professional in accordance with The Companies' installation instructions and local building codes. The warranty on the appliance covers only components manufactured by The Companies. The use of components manufactured or supplied by other manufacturers and used in conjunction with the appliance could create serious safety hazards, may result in the denial of certification by recognized national safety agencies and could violate local building codes. Such use may untimely void this warranty. This warranty does not cover any damages occurring from the use of any components not manufactured or supplied by The Companies.

The appliance must be subjected to normal use. The appliance is designed to burn natural gas (NG) or liquefied petroleum (LP) only. Burning conventional fireplace fuels such as wood, coal or any other solid fuel will cause damage to the appliance, produce excessive temperatures will result in a fire hazard and void all

warranties. This warranty is transferable. The appliance must remain in its original place of installation to be valid.

If the components of the appliance covered by this warranty are found to be defective within the time frame stated (see The Companies investigation of claims), The Companies will, at its option, replace or repair defective components of the appliance manufactured by The Companies at no charge and will also pay for labor costs (in accordance with schedule) incurred in replacing or repairing components. If repair or replacement is not commercially practical, The Companies will, at its sole discretion, fully discharge all obligations under the warranty by refunding the verified dealer purchase price of the appliance, excluding the cost of labor unless the labor is covered by the terms of the warranty.

This warranty covers only parts and labor as provided above. In no case shall the companies be responsible for materials, components or construction, which are not manufactured or supplied by The Companies, or for the labor necessary to install, repair or remove such materials, components or construction. All replacement or repair components will be shipped F.O.B. from the nearest Company factory.

### LIMITATION ON LIABILITY

It is agreed and understood that The Companies sole obligation, and purchaser's exclusive remedy under this warranty, under any other warranty, expressed or implied, or in contract, tort or otherwise, shall be limited to repair, replacement or refund as specified above. The opinion of The Companies with respect to these matters shall be final.

In no event shall The Companies be responsible for any incidental or consequential damages caused by (but not limited to) improper installation, installation by an unqualified or unauthorized installer, accident, lack of regular maintenance, user error, abuse, misuse, Acts of God, power surges, floods, natural disasters, force majeure, defects in its appliance whether such damage occurs or is discovered before or after replacement or repair, and whether or not such damage is caused by The Companies negligence. Some jurisdictions do not allow the exclusion or limitation of incidental or consequential damages, so the above limitation or exclusion may not apply to you. The duration of any implied warranty with respect to the appliance is limited to the duration of the foregoing warranty. Some jurisdictions do not allow limitations on how long an implied warranty lasts, so the above limitation or exclusion may not apply to you.

## Appendix B: Warranty Continued

### EXCLUSIONS TO WARRANTY

Corrosion or rust of any kind due to a lack of maintenance, inadequate combustion air or improper venting and corrosive chemicals/environments, expansion and contraction of metals or minor movements of components causing noise are not covered by this warranty.

Willful misconduct (i.e. use of the appliance with problems known to the purchaser and causing further damages), including unauthorized or self-performed 'fixing' or exploration of the appliance's internal workings will void the warranty.

Appliances on which the serial number has been altered, defaced, removed or made illegible will void the warranty.

Costs incurred for diagnosis, service work, shipping and handling of defective or replacement parts are not covered under this warranty.

The published warranties are not applicable for any equipment manufactured by The Companies that has been sold direct to the consumer via internet or auction websites. The Companies do not endorse, approve or certify any online sale of its products through auction websites, online retailers or any other method of online sales direct to consumers.

### INVESTIGATION OF CLAIMS AGAINST WARRANTY

The Companies reserve the right to investigate any and all claims against this warranty and decide upon method of settlement.

The Companies are not responsible for work done without written consent of The Companies.

The Companies shall in no event be responsible for any warranty work done without first obtaining the Companies written consent.

The Companies employees and dealers have no authority to make any warranties to neither alter this warranty nor authorize any remedies in addition to or inconsistent with those stated within this warranty.

### IF WARRANTY SERVICE IS NEEDED

To make a claim under this warranty, contact your installing dealer or contractor. The installing dealer is responsible for providing service and will contact the companies to initiate warranted parts replacements. In the event the installing dealer is unavailable, contact your nearest authorized Montigo dealer ([www.Montigo.com](http://www.Montigo.com)) or contact Montigo direct at [techsupport@montigo.com](mailto:techsupport@montigo.com). Ensure you have your sales receipt and the model and serial number of your appliance.

### DO NOT ATTEMPT TO DO ANY SERVICE WORK YOURSELF

If you cannot locate the installing dealer, or nearest dealer/ distributor, you must notify The Companies in writing.

### USA Offices

6955 Salashan Parkway  
Ferndale WA, 98248  
[techsupport@montigo.com](mailto:techsupport@montigo.com)

### Canadian Offices

27342 Gloucester Way  
Langley, BC V4W 4A1  
[techsupport@montigo.com](mailto:techsupport@montigo.com)

The terms and conditions of this warranty may be altered or amended from time to time without prior notice.

**WARRANTY PERIOD:** Warranty coverage begins on the date of original purchase. In the case of new construction, warranty coverage begins on the date of first occupancy of the dwelling or six months after the sale of the product by an independent, authorized Company dealer/ distributor, whichever occurs earlier.

## Appendix C: Amendment

(Gas Fireplace / Equipment sold in the State of Massachusetts)

### 5.08: Modifications to NFPA-54, Chapter 10

- (1) Revise NFPA-54 section 10.5.4.2 by adding a second exception as follows:

Existing chimneys shall be permitted to have their use continued when a gas conversion burner is installed, and shall be equipped with a manually reset device that will automatically shut off the gas to the burner in the event of a sustained back-draft.

- (2) Revise 10.8.3 by adding the following additional requirements:

- (a) For all side wall horizontally vented gas fueled equipment installed in every dwelling, building or structure used in whole or in part for residential purposes, including those owned or operated by the Commonwealth and where the side wall exhaust vent termination is less than seven (7) feet above finished grade in the area of the venting, including but not limited to decks and porches, the following requirements shall be satisfied:

1. **INSTALLATION OF CARBON MONOXIDE DETECTORS.** At the time of installation of the side wall horizontal vented gas fueled equipment, the installing plumber or gas fitter shall observe that a hard wired carbon monoxide detector with an alarm and battery back-up is installed on the floor level where the gas equipment is to be installed. In addition, the installing plumber or gas fitter shall observe that a battery operated or hard wired carbon monoxide detector with an alarm is installed on each additional level of the dwelling, building or structure served by the side wall horizontal vented gas fueled equipment. It shall be the responsibility of the property owner to secure the services of qualified licensed professionals for the installation of hard wired carbon monoxide detectors
  - a. In the event that the side wall horizontally vented gas fueled equipment is installed in a crawl space or an attic, the hard wired carbon monoxide detector with alarm and battery back-up may be installed on the next adjacent floor level.
  - b. In the event that the requirements of this subdivision can not be met at the time of completion of installation, the owner shall have a period of thirty (30) days to comply with the above requirements; provided, however, that during said thirty (30) day period, a battery operated carbon monoxide detector with an alarm shall be installed.
2. **APPROVED CARBON MONOXIDE DETECTORS.** Each carbon monoxide detector as required in accordance with the above provisions shall comply with NFPA 720 and be ANSI/UL 2042 listed and IAS certified.
3. **SIGNAGE.** A metal or plastic identification plate shall be permanently mounted to the exterior of the building at a minimum height of eight (8) feet above grade directly in line with the exhaust vent terminal for the horizontally vented gas fueled heating appliance or equipment. The sign shall read, in print size no less than one-half (1/2) inch in size, "GAS VENT DIRECTLY BELOW. KEEP CLEAR OF ALL OBSTRUCTIONS".

4. **INSPECTION.** The state or local gas inspector of the side wall horizontally vented gas fueled equipment shall not approve the installation unless, upon inspection, the inspector observes carbon monoxide detectors and signage installed in accordance with the provisions of 248 CMR 5.08(2)(a)1 through 4.

- (b) **EXEMPTIONS:** The following equipment is exempt from 248 CMR 5.08(2)(a)1 through 4:

1. The equipment listed in Chapter 10 entitled "Equipment Not Required To Be Vented" in the most current edition of NFPA 54 as adopted by the Board; and
  2. Product Approved side wall horizontally vented gas fueled equipment installed in a room or structure separate from the dwelling, building or structure used in whole or in part for residential purposes.
- (c) **MANUFACTURER REQUIREMENTS - GAS EQUIPMENT VENTING SYSTEM PROVIDED.** When the manufacturer of Product Approved side wall horizontally vented gas equipment provides a venting system design or venting system components with the equipment, the instructions provided by the manufacturer for installation of the equipment and the venting system shall include:
1. Detailed instructions for the installation of the venting system design or the venting system components; and
  2. A complete parts list for the venting system design or venting system.
- (d) **MANUFACTURER REQUIREMENTS - GAS EQUIPMENT VENTING SYSTEM NOT PROVIDED.** When the manufacturer of a Product Approved side wall horizontally vented gas fueled equipment does not provide the parts for venting the flue gases, but identifies "special venting systems", the following requirements shall be satisfied by the manufacturer:
1. The referenced "special venting system" instructions shall be included with the appliance or equipment installation instructions; and
  2. The "special venting systems" shall be Product Approved by the Board, and the instructions for that system shall include a parts list and detailed installation instructions.
- (e) A copy of all installation instructions for all Product Approved side wall horizontally vented gas fueled equipment, all venting instructions, all parts lists for venting instructions, and/or all venting design instructions shall remain with the appliance or equipment at the completion of the installation.

- (3) After NFPA-54 section 10.10.4.2 add a new section 10.10.4.3 as follows:

When more than four gas appliances are to be vented through a common gas vent or common horizontal vent manifold, a plan of the proposed vent installation shall be submitted to the Inspector and the serving gas supplier for review and approval.

Extraction from: Massachusetts Rules and Regulations

5.00: Amendments To 2002 Edition Of ANSI Z223.1-NFPA-54

# DelRay

Single Sided Gas Fireplace