



Owner's Manual

6909410210

6909410110

6909680110

Model

VF5452L

VF2927L

VFA2927

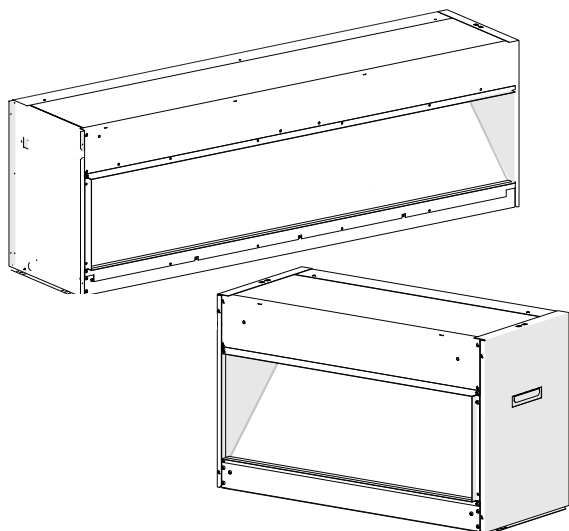







IMPORTANT SAFETY INFORMATION: Always read this manual first before attempting to install or use this Opti-V. For your safety, always comply with all warnings and safety instructions contained in this manual to prevent personal injury or property damage.

To view the full line of Dimplex products, please visit
www.dimplex.com

7213460100R04



Table of Contents

 Welcome & Congratulations	3
 IMPORTANT SAFETY INSTRUCTIONS.	4
 Opti-V Installation	6
Locating the Opti-V	6
Hardwire Installation	6
 Operation	10
 Maintenance	12
 Warranty.	13
 Technical Support.	15

Always use a qualified technician or service agency to repair this Opti-V.

! NOTE: Procedures and techniques that are considered important enough to emphasize.

⚠ CAUTION: Procedures and techniques which, if not carefully followed, will result in damage to the equipment.

⚡ WARNING: Procedures and techniques which, if not carefully followed, will expose the user to the risk of fire, serious injury, or death.

Welcome & Congratulations

Thank you and congratulations for purchasing an Opti-V from Dimplex. Please use our convenient online registration page to record your model and serial numbers for future reference at

www.dimplex.com/register

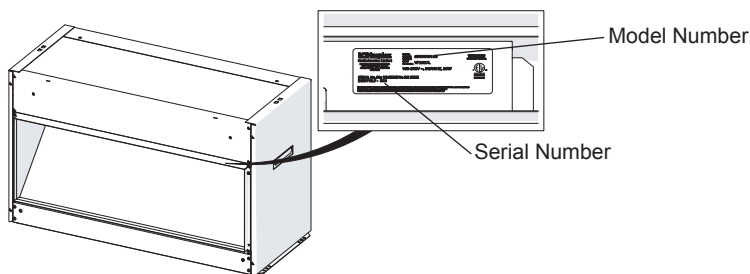

Please carefully read and save these instructions.

⚠ CAUTION: Read all instructions and warnings carefully before starting installation. Failure to follow these instructions may result in a possible electric shock, fire hazard and will void the warranty.

STOP NO NEED TO RETURN TO THE STORE

Questions with operation or assembly? Require Parts Information?
Product Under Manufacturer's Warranty?

Contact us at:  **www.dimplex.com/customer_support**
For Troubleshooting and Technical Support

OR  **Toll-Free 1-888-DIMPLEX (1-888-346-7539)**

Monday to Friday 8:00 a.m. to 4:30 p.m. EST

In order to better serve you, please have your model and serial number ready or register your product online before calling (See above)

IMPORTANT SAFETY INSTRUCTIONS

When using electrical appliances, basic precautions should always be followed to reduce the risk of fire, electric shock, and injury to persons, including the following:

1. Read these instructions.
 2. Keep these instructions.
 3. Heed all warnings.
 4. Follow all instructions.
 5. Do not use this apparatus near water.
 6. The appliance shall not be exposed to dripping or splashing and that no objects filled with liquid, such as vases, shall be placed on the apparatus.
-  **WARNING:** To reduce the risk of fire or electric shock, do not expose this apparatus to rain or moisture.
7. Clean only with dry cloth.
 8. Do not block any ventilation openings. Install in accordance with the manufacturer's instructions.
 9. Do not install near any heat sources such as radiators, heat registers, stoves, or other apparatus (including amplifiers) that produce heat.
 10. No naked flame sources, such as candles should be placed on this apparatus.
 11. Only use attachments/accessories specified by the manufacturer.
 12. Use only with the cart, stand, tripod, bracket, or table specified by the manufacturer, or sold with the apparatus. When a cart is used, use caution when moving the cart/apparatus combination to avoid injury from tip-over.
 13. Disconnect power at the service panel during lightning storms or when unused for long periods of time.
 14. Refer all servicing to qualified service personnel. Servicing is required when the apparatus has been damaged in any way, such as power-supply cord or plug is damaged, liquid has been spilled or objects have fallen into the apparatus, the apparatus has been exposed to rain or moisture, does not operate normally, or has been dropped.
 15. If the appliance is damaged, check immediately with the supplier before installation and operation.
 16. Do not operate any unit with a damaged cord, or if the Opti-V has been dropped or damaged in any manner, contact Dimplex Technical Service at 1-888-346-7539.
 17. Do not modify the Opti-V. Use it

IMPORTANT SAFETY INSTRUCTIONS

only as described in this manual. Any other use not recommended by the manufacturer may cause fire, electric shock or injury to persons.

18. When transporting or storing the unit and cord, keep in a dry place, free from excessive vibration and store so as to avoid damage.
19. Do not install the remote control battery backwards; charge; put in excessive heat such as fire, sunshine or the like; or mix with used or other battery types - may explode or leak causing injury.
20. When replacing the battery ensure that it is replaced with alkaline 1.5 Volt (AAA) batteries. Battery must be recycled or disposed of properly. Check with your Local Authority or Retailer for recycling advice in your area.

! NOTE: To disconnect from mains - set the mains switch to 'O'. The mains (power) switch is located at the top left hand side of the appliance above the manual controls - see 'O/I' Figure 2. Mains switch shall remain readily operable.

 WARNING: To prevent injury, this apparatus must be securely attached to the floor/wall in accordance with the installation instructions.

 WARNING: Remote control contains small batteries. Keep away from children. If swallowed, seek medical attention immediately.

! NOTE: Changes or modifications not expressly approved by the party responsible for compliance could void user's authority to operate the equipment.



CAUTION
RISK OF ELECTRIC SHOCK
DO NOT OPEN
NO USER-SERVICEABLE PARTS INSIDE



SAVE THESE INSTRUCTIONS

Opti-V Installation

⚠ WARNING: ANY INSTALLATION AND SERVICE WORK CAN ONLY BE PERFORMED BY QUALIFIED AND AUTHORIZED PERSONNEL. ALL INSTALLATIONS MUST COMPLY WITH ALL LOCAL CODES AND BY-LAWS, AND INSPECTED AND APPROVED FOR OPERATION BY LOCAL GOVERNING AUTHORITY PRIOR TO USE.

⚠ WARNING: Construction and electrical outlet wiring must comply with local building codes and other applicable regulations to reduce the risk of fire, electric shock and injury to persons.

Locating the Opti-V

The Opti-V uses an illusory reflection technique and is designed to work best when ambient light levels are low. If the Opti-V is installed in brightly lit areas, the strong reflections may diminish the flame.

Depending on your specific application, installation of the unit at a height appropriate for the viewers enjoyment is important. It is recommended that the following guidelines be used for locating the unit.

! NOTE: Measurements are to the bottom of the viewing area of the flame.

For standing applications:

Maximum - 51 in. (129.5 cm)
Minimum - 26 in. (66.0 cm)

For sitting applications:

Maximum - 36 in. (91.4 cm)
Minimum - 26 in. (66.0 cm)

Hardwire Installation

The Opti-V is supplied in an assembled state and is designed to be permanently installed. The unit comes ready for hardwire installation.

⚠ WARNING: Do not attempt to wire your own new outlets or circuits. To reduce the risk of fire, electric shock or injury to persons, always use a licensed electrician.

⚠ WARNING: Ensure that the On/Off switch is set to the Off position (refer to Operation section) and that the circuit on which the Opti-V is to be installed has the power cut off at the service panel until installation is complete.

! NOTE: Please read all instructions before installing.

1. For rough in framing, the opening should follow the

Opti-V Installation

recommended dimensions located in Figure 1.

! NOTE: Dimensions provided are minimum clearances and will vary depending on type of support framing and finishing options.

! NOTE: Framing should be constructed to support:

VF2927L / VFA2927 - 63 lbs (29 kg)

VF5452L - 116 lbs (52 kg)

2. Allow up to 4 ft. (121.9 cm) of service cable for connecting

a power supply wire to the cable clamp on the Opti-V when installing before finishing wall.

! NOTE: A 15 amp, 120 volt alternating current (VAC) circuit is recommended, but the unit is constructed that it can operate using voltages from 120-240VAC.

! NOTE: Use minimum 14 AWG supply cable with two insulated copper conductors (white and black) and one bare ground wire.

Figure 1

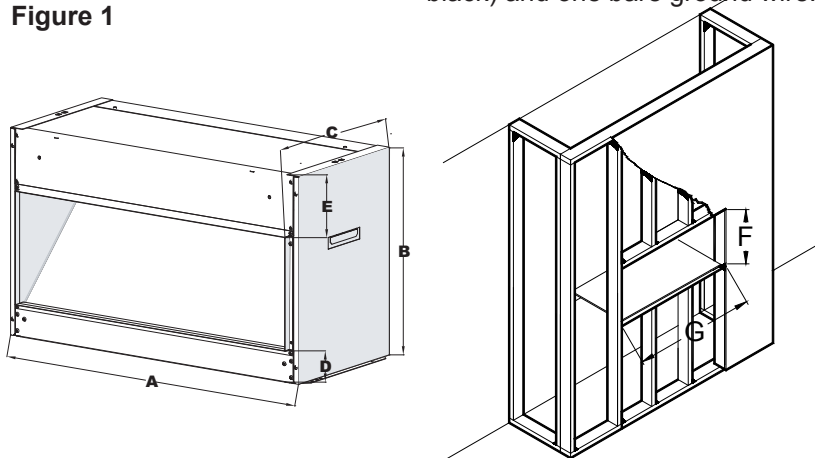

	A	B	C	D	E	F	G
VF5452L	53.4 in (1356 mm)	17.7 in (450 mm)	13.6 in (345 mm)	2.9 in (74 mm)	5.3 in (135 mm)	18.6 in (474 mm)	55.3 in (1404 mm)
VF2927L	29.0 in (736 mm)	17.7 in (450 mm)	13.6 in (345 mm)	2.9 in (74 mm)	5.3 in (135 mm)	18.6 in (474 mm)	29.9 in (760 mm)
VFA2927	29.0 in (736 mm)	17.7 in (450 mm)	13.6 in (345 mm)	2.9 in (74 mm)	5.3 in (135 mm)	18.6 in (474 mm)	29.9 in (760 mm)

Opti-V Installation

Do not use cable with aluminum conductors.

! NOTE: It is recommended that all drywall installation and finishing be completed after unit is fully installed.

3. In the upper left hand corner of the unit, loosen the two securing screws and remove the electrical cover panel. (Figure 2)
4. Install a $\frac{3}{8}$ in. (10 mm) or $\frac{1}{2}$ in. (13 mm) cable connector, not included, suitable for mounting in a $\frac{7}{8}$ in. (22 mm) hole, to the cable plate and feed the supply cable through the connector and secure.
5. Place the unit in the framed opening, level with shims if

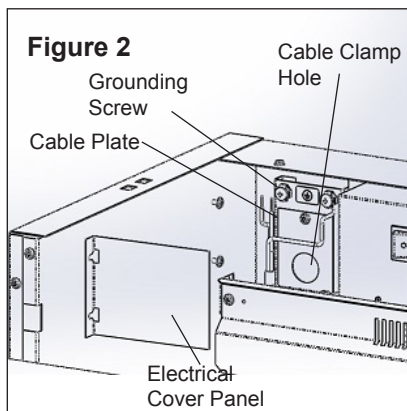

necessary and attach unit to frame using mounting flanges provided (Figure 3).

- ⚠ CAUTION:** When inserting the unit take care not to damage or pinch any of the power cables that are concealed in the wall.
6. Remove the outer jacket and strip the individual conductors $\frac{1}{2}$ in. (1.3 cm) from the end.
 7. Connect the black wire from the unit to the Live (120V) or Line 1 (240V) wire from the power supply using a wire connector (included).
 8. Connect the white wire from the unit to the Neutral (120V) or Line 2 (240V) from the power supply using a wire connector (included).

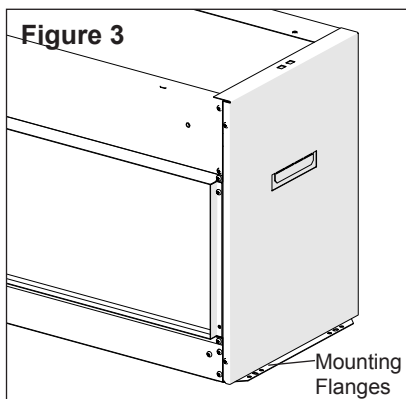

Opti-V Installation

! NOTE: Cap any additional wires from the power supply not used in the installation.

9. Ensure that the green grounding wire is securely attached to the back plate.

⚠ CAUTION: Ensure the wire connectors are securely tightened, so no bare wires (live or neutral) are exposed.

10. Ensure the grounding wire of the supply cable is securely attached to the grounding screw.

! NOTE: The wire connections on the Opti-V feed into a 3-prong plug just below the electrical cavity opening, before closing the electrical cover ensure that the plug is fully installed.

11. Reinstall the electrical cover panel.

12. Reinstall the protector sheet to prevent dust from entering the unit while finishing the surround.

13. Finish surrounding wall. There are 3 different options for finishing the wall:

- **Permanent** - install drywall right up to the flange that surrounds the opening.
- **Semi Permanent** - finish around edge using flashing material (not included)
- **Flexible** - create opening big enough to access mounting flanges and a false front that can be removed.

Operation

Figure 2

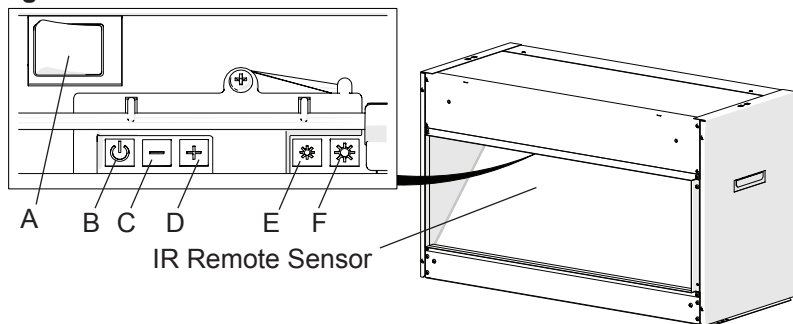

⚠ WARNING: This Opti-V must be properly installed before it is used.

The power switch (Figure 2A) must first be switched "I" to operate the appliance.

An 'Opti-V' logo will appear on the screen for about 3 seconds before the flame picture starts .

! NOTE: The user may notice a blank screen for approximately 5 seconds, every 30 minutes. This is normal and should not be a cause for concern.

Manual Operation

The manual controls for the screen are located at the inner top left hand side of the appliance above the glass.(Figure 2).

The mains (power) switch (Figure

2A) may be used to switch the appliance Off ("O") when it is not required, for example, overnight or for long periods, to avoid unnecessary energy use.

! NOTE: Ensure that the mains (power) switch shall remain readily operable.

The standby button "⏻" (Figure 2B) is located just below the power switch. A red light will indicate when the unit is in standby mode. (Figure 2)

The volume of the sound effects may be adjusted up or down by pressing the volume control buttons (Figure 2C & 2D).

The screen brightness can be adjusted using the * (Figure 2E) and ☀ (Figure 2F) buttons. The * button darkens the screen and the

Operation

 button brightens the screen.

! NOTE: On the VF5452L there are brightness controls for each LED screen. The brightness controls for the right screen are located in the center of the unit.

Remote Control Operation

The remote control may be operated once the appliance is switched to the ON "I" position (Figure 2A).

Aim the remote control at the IR remote sensor located on the left of the display (Figure 2). The volume may be adjusted up or down by pressing the volume control buttons (+ and -).

Battery Replacement

! NOTE: The remote control is packed separately in the carton.

1. Slide battery cover open on the remote control (Figure 3).
2. Correctly install 2 1.5 Volt (AAA) battery in the battery holder.
3. Close the battery cover.



Battery must be recycled or disposed of properly. Check with your Local

Authority or Retailer for recycling advice in your area.

Figure 3

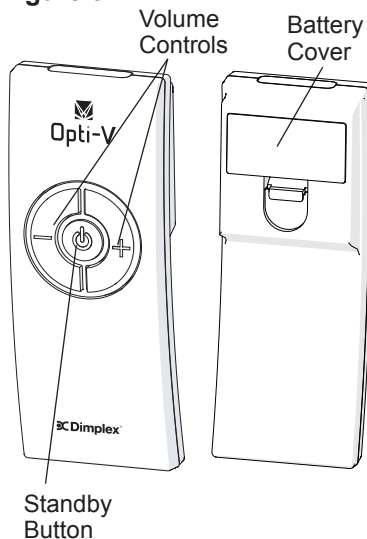



Maintenance

⚠ WARNING: Disconnect power before attempting any maintenance or cleaning to reduce the risk of fire, electric shock or damage to persons.

Glass Cleaning

The glass is cleaned in the factory during the assembly operation. During shipment, installation, handling, etc., the front glass may collect dust particles, these can be removed by dusting lightly with a clean dry cloth.

To remove fingerprints or other marks, the glass can be cleaned with a dry cloth. The glass should be completely dried with a lint free cloth to prevent water spots. To prevent scratching, do not use abrasive cleaners or spray liquids on the glass surface.

Opti-V Surface Cleaning

To remove fingerprints or other marks, the exterior finish can be cleaned with a damp cloth with a mild detergent. The surface should be completely dried with a lint free cloth to prevent water spots.

Servicing

Except for installation and cleaning described in this manual, an authorized service representative should perform any other servicing.

Warranty

Two Year Limited Warranty

Products to which this limited warranty applies

This limited warranty applies to the following models of your newly purchased Dimplex Opti-V: **VF5452L, VF2927L and VFA2927** and to newly purchased Dimplex surrounds (mantels) and trims. This limited warranty applies only to purchases made in any province of Canada *except* for Yukon Territory, Nunavut, or Northwest Territories or in any of the 50 States of the USA (and the District of Columbia) *except* for Hawaii and Alaska. This limited warranty applies to the original purchaser of the product only and is not transferable.

Products excluded from this limited warranty

Light bulbs are not covered by this limited warranty and are the sole responsibility of the owner/purchaser. Products purchased in Yukon Territory, Nunavut, Northwest Territories, Hawaii, or Alaska are not covered by this limited warranty. Products purchased in these States, provinces, or territories are sold AS IS without warranty or condition of any kind (including, without limitation, any implied warranties or conditions of merchantability or fitness for a particular purpose) and the entire risk of as to the quality and performance of the products is with the purchaser, and in the event of a defect the purchaser assumes the entire cost of all necessary servicing or repair.

What this limited warranty covers and for how long

Products, other than surrounds (mantels) and trims, covered by this limited warranty have been tested and inspected prior to shipment and, subject to the provisions of this warranty, Dimplex warrants such products to be free from defects in material and workmanship for a period of 2 years from the date of the first purchase of such products.

Dimplex surrounds (mantels) and trims covered by this limited warranty have

been tested and inspected prior to shipment and, subject to the provisions of this warranty, Dimplex warrants such products to be free from defects in material and workmanship for a period of 1 year from the date of first purchase of such products.

The limited 2 year warranty period for products other than surrounds (mantels) and trims and the limited 1 year warranty period for surrounds (mantels) and trims also applies to any implied warranties that may exist under applicable law. Some jurisdictions do not allow limitations on how long an implied warranty lasts, so the above limitation may not apply to the purchaser.

What this limited warranty does not cover

This limited warranty does not apply to products that have been repaired (except by Dimplex or its authorized service representatives) or otherwise altered. This limited warranty does further not apply to defects resulting from misuse, abuse, accident, neglect, incorrect installation, improper maintenance or handling, or operation with an incorrect power source.

What you must do to get service under this limited warranty

Defects must be brought to the attention of Dimplex Technical Service by contacting Dimplex at 1-888-DIMPLEX (1-888-346-7539), or 1367 Industrial Road, Cambridge Ontario, Canada N3H 4W3. Please have proof of purchase, catalogue/model and serial numbers available when calling. Limited warranty service requires a proof of purchase of the product.

What Dimplex will do in the event of a defect

In the event a product or part covered by this limited warranty is proven to be defective in material or workmanship during (i) the 2 year limited warranty period for products other than surrounds (mantels) and trims, and (ii) the 1 year limited warranty period for surrounds (mantels) and trims, you have the following rights:

- Dimplex will in its sole discretion either



Warranty

repair or replace such defective product or part without charge. If Dimplex is unable to repair or replace such product or part, or if repair or replacement is not commercially practicable or cannot be timely made, Dimplex may, in lieu of repair or replacement, choose to refund the purchase price for such product or part.

- Limited warranty service will be performed solely by dealers or service agents of Dimplex authorized to provide limited warranty services.
- **For products other than surrounds (mantels) and trims**, this 2 year limited warranty entitles the purchaser to on-site or in-home warranty services. Accordingly, Dimplex will be responsible for all labour and transportation associated with repairing or replacing the product or part except as follows: (i) charges which may be levied for travel costs incurred to travel to the purchaser's site where the product is located if the purchaser's site is beyond 30 miles (48 km) from the closest service depot of Dimplex's dealer or service agent; and (ii) the purchaser is solely responsible for providing clear access to all serviceable parts of the product.
- **For surrounds (mantels) and trims**, this 1 year limited warranty does not entitle the purchaser to on-site or in-home warranty services. The purchaser is responsible for removal and transportation of the surrounds (mantels) and trims (and any repaired or replacement product or part) to and from the authorized dealer's or service agent's place of business. On-site or in-home services for surrounds (mantels) and trims may be performed at the purchaser's specific request and expense at Dimplex's then-current rates for such services. Dimplex will not be responsible for, and this limited warranty shall not include, any expense incurred for installation or removal of the surrounds (mantels) or trims or any part thereof (or any

replacement product or part) including, without limitation, all shipping costs and transportation costs to and from the authorized dealer's or service agent's place of business and all labour costs. Such costs shall be the purchaser's responsibility.

What Dimplex and its dealers and service agents are also not responsible for:

IN NO EVENT WILL DIMPLEX, OR ITS DIRECTORS, OFFICERS, OR AGENTS, BE LIABLE TO THE PURCHASER OR ANY THIRD PARTY, WHETHER IN CONTRACT, IN TORT, OR ON ANY OTHER BASIS, FOR ANY INDIRECT, SPECIAL, PUNITIVE, EXEMPLARY, CONSEQUENTIAL, OR INCIDENTAL LOSS, COST, OR DAMAGE ARISING OUT OF OR IN CONNECTION WITH THE SALE, MAINTENANCE, USE, OR INABILITY TO USE THE PRODUCT, EVEN IF DIMPLEX OR ITS DIRECTORS, OFFICERS, OR AGENTS HAVE BEEN ADVISED OF THE POSSIBILITY OF SUCH LOSSES, COSTS OR DAMAGES, OR IF SUCH LOSSES, COSTS, OR DAMAGES ARE FORESEEABLE. IN NO EVENT WILL DIMPLEX, OR ITS OFFICERS, DIRECTORS, OR AGENTS BE LIABLE FOR ANY DIRECT LOSSES, COSTS, OR DAMAGES THAT EXCEED THE PURCHASE PRICE OF THE PRODUCT.

SOME JURISDICTIONS DO NOT ALLOW THE EXCLUSION OR LIMITATION OF INCIDENTAL OR CONSEQUENTIAL DAMAGES, SO THE ABOVE LIMITATION OR EXCLUSION MAY NOT APPLY TO THE PURCHASER.

How State and Provincial law apply

This limited warranty gives you specific legal rights, and you may also have other rights which vary from jurisdiction to jurisdiction. The provisions of the United Nations Convention on Contracts for the Sale of Goods shall not apply to this limited warranty or the sale of products covered by this limited warranty.



Technical Support

Technical and troubleshooting support, as well as a list of replacement parts can be found on

www.dimplex.com/customer_support.



Dimplex North America Limited

1367 Industrial Road
Cambridge ON
Canada N3H 4W3

© 2016 Dimplex North America Limited