



CARRIER® DUCTLESS & VRF SYSTEMS

## What's Next in Comfort



## Table of Contents

- 4 – Ductless Benefits
- 14 – Single Zone and Multi-zone Product Lineup
- 17 – Single Zone Products
- 43 – Multi-zone Products
- 55 – Light Commercial Products
- 87 – Glossary











Preferred in homes throughout Europe and Asia for decades, ductless heating and cooling systems are now being widely adopted in the United States. That's because they can heat and cool any space with precise control and flexibility.

Whether it's through a Ductless unit to heat or cool one room or a VRF system that helps ensure desired comfort for multiple rooms or zones, Carrier offers solutions to make any space a more comfortable place.



**Whether the need is for one room or many, this is what comfort looks like.**



Carrier Ductless & VRF systems are a smart way to heat and cool any space.







## It's that simple.

Almost everyone has a room that always seems drafty, a sunroom that gets too hot to be enjoyable, a master bedroom that's just not cool enough at night or a basement that never gets quite warm enough to be comfortable.

A Ductless or VRF system can fix these problem areas with less expense and hassle than a traditional ducted system. Whether it's through a Single Zone Ductless system for one room or a Multi-zone VRF option to provide comfort to multiple areas, Carrier can help make any space more livable.



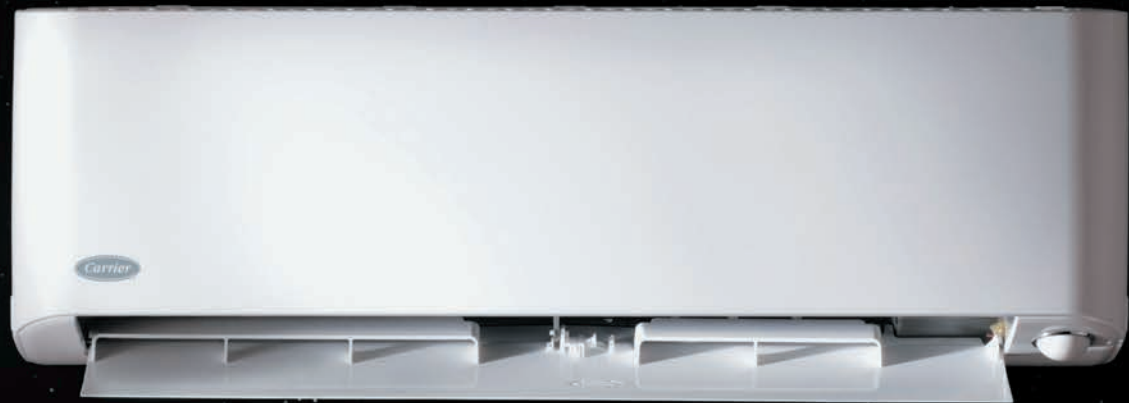

**Carrier Ductless & VRF systems  
make any space a more comfortable place.**



# 5 Reasons Why Ductless Systems Are So Efficient



## **Inverter Technology**

The compressors in most ducted systems only have two modes: on or off. Compressor start-up consumes a lot of energy, and it can be noisy, too. But the inverter technology inside every Carrier® Ductless system lets the compressor continually adjust its speed to keep the room temperature where it should be. Less energy use, less noise, more precise comfort.



## **Efficiency**

SEER (Seasonal Energy Efficiency Ratio) is an efficiency rating, much like the MPG on a car. There is simply nothing more efficient than our newest 42 SEER Ductless system.\*



## **Room-By-Room Comfort**

With a Ductless system, you no longer need to overcool the whole house just to make an upstairs room more comfortable or turn up the heat to warm a basement playroom in the winter. Just room-by-room comfort and month-to-month energy savings.



## **No Leaks**

A home can lose 30% or more of heating and cooling energy due to natural leaks in its ductwork. With a Ductless system, air flows directly from the outdoor unit to the indoor space through a refrigerant pipe, so there's little to no energy lost.



## **Flexibility**

With multiple Ductless or VRF solutions to choose from, a Carrier expert can help ensure a system is properly sized to ensure maximum comfort and efficiency.

\*According to system ratings maintained by AHRI as of January 22, 2018 in accordance with the AHRI Unitary Small Equipment Operations Manual. The 9,000 Btu/h Single Zone ductless has a 42 SEER Rating.





# Ductless & VRF Systems Make More of Your Home More Comfortable

Even the most challenging areas to control can be turned into comfortable, usable spaces with the addition of a Ductless system.



## Fresher, Cleaner Air

The washable filters inside Carrier® Ductless systems remove airborne particles and keep them from recirculating in your home's air, and they are easy to maintain. Plus, our top-of-the-line systems allow you to precisely control humidity levels so rooms never feel too damp or too dry.



## Smart Controls

Carrier Ductless systems have standard Wi-Fi® connectivity that lets you adjust settings from your smartphone and integrated sensors that can direct airflow toward the people in the room.



## Easy Install

A Ductless system consists of an outdoor unit and an indoor unit connected by refrigerant pipe and electric cable, which enter the house through a 3" hole in the wall. That's it. Installation is quick and minimally disruptive to your space.



## Multiple Zones

A Carrier Ductless Multi-zone or VRF condensing unit can power multiple indoor units simultaneously, helping to achieve the desired comfort level for each and every room.

More than one troubled spot? Carrier VRF systems offer solutions to heat and cool multiple areas throughout your home.

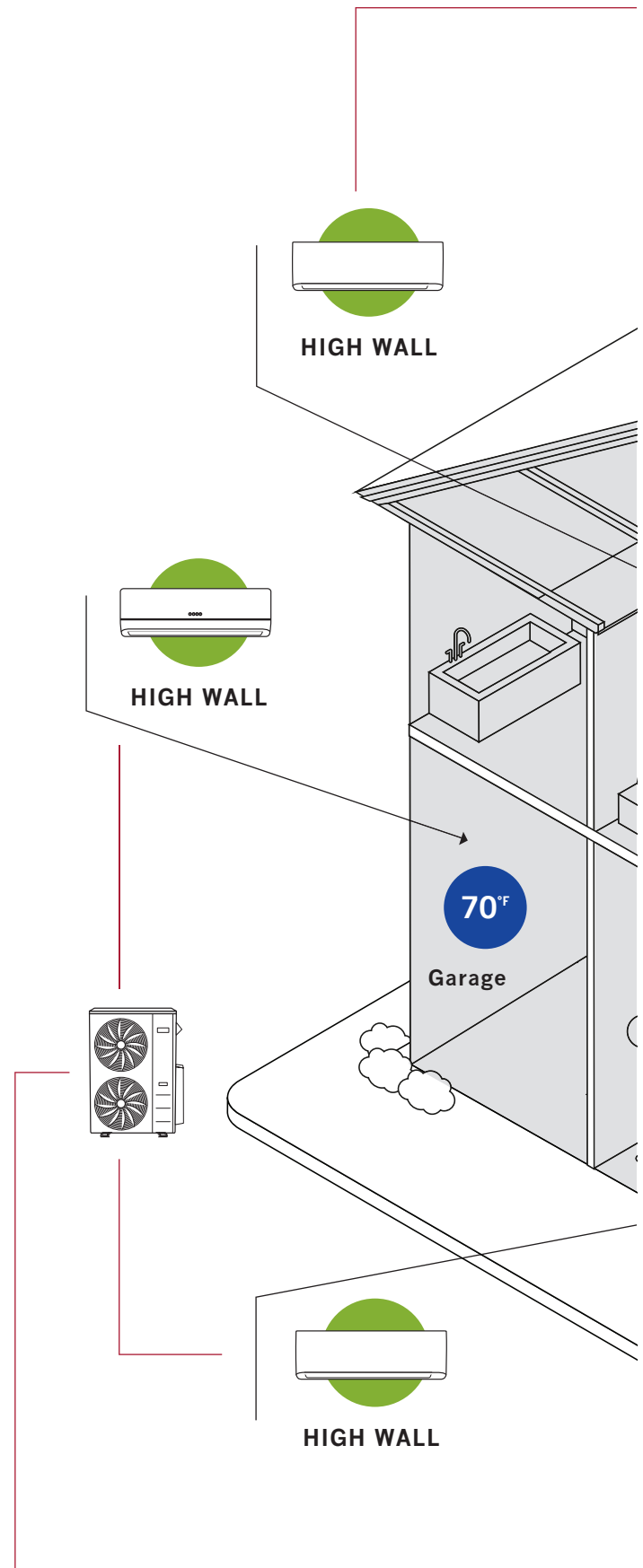



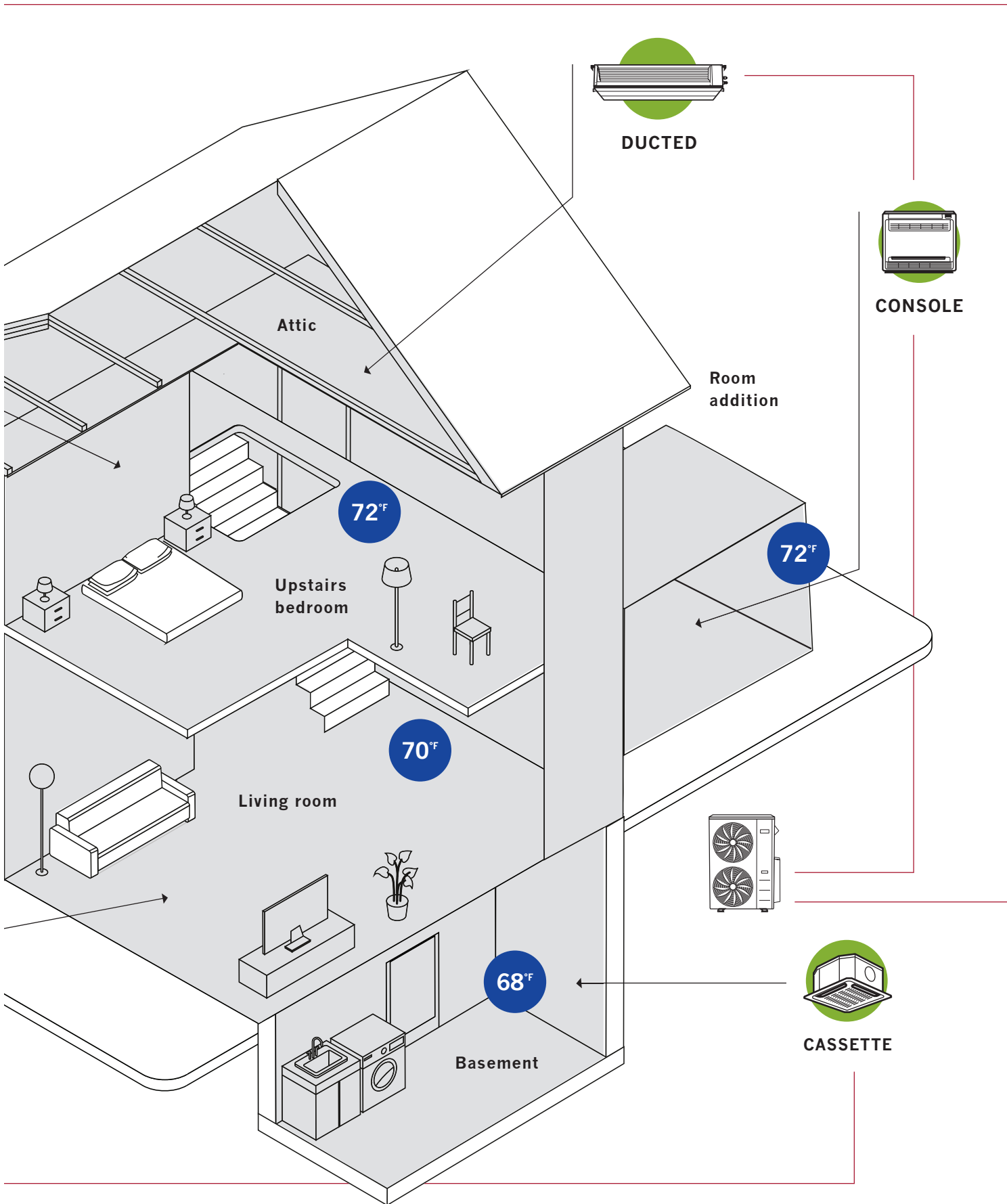



## The Brand That Has Never Stopped Innovating

Built on Willis Carrier's invention of modern air conditioning in 1902, Carrier is a world leader in heating, air-conditioning and refrigeration solutions. We constantly build upon our history of proven innovation with new products and services that improve global comfort and efficiency.

But our innovation doesn't stop there. From the hiring of the first woman air-conditioning engineer to the creation of the first air-conditioning systems for skyscrapers, homes, factories and ships, Carrier continues to look for ways to advance comfort.

As a trusted partner for precise temperature and humidity control for highly regarded places such as the Sistine Chapel in Vatican City and George Washington's estate in Virginia, we know a thing or two about innovation. And it's this same innovation that we put to work in your home.





# The Reviews Are in for Carrier® Ductless Systems.

*At the time Ductless products started getting popular, we were forced to use an inferior brand which caused installation issues in the field and plenty of warranty calls for our service department. When Carrier came out with its Ductless line, we were thrilled! As a factory authorized dealer for Carrier we already knew the **quality and reliability** would be there, and we were not disappointed.*

**Shannon Nielsen**  
VICE PRESIDENT OF OPERATIONS OF  
AIRPLUS OF CALIFORNIA, INC.

*Hawaii has a very competitive mini-split/Ductless market. With many different options available, Carrier DLS provides **a good product with competitive pricing**. Backed by a big name in the industry, given time and good advertising, Carrier DLS/mini-splits will be a bigger player in this market.*

**Richard Chong**  
DUCTLESS DEALER AND INNOVATIVE  
AC OWNER

*Fayette Furnace Company has been installing ductless split units for at least the last decade. We started installing these units in homes and businesses that had areas that needed additional cooling. As time progressed and efficiencies improved, the systems became more and more desirable for use throughout the entire home or building for BOTH heating and cooling. Now we are doing very limited ducted attic jobs and increasing ductless split installations, with some applications using the ductless splits as the **primary heating and cooling year round**. These systems are **ideal for any application**.*

**Michael T. Salanick**  
OWNER/PRESIDENT OF FAYETTE  
FURNACE COMPANY

## Single Zone

INFINITY SERIES

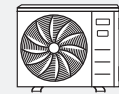

38MPRA  
OUTDOOR UNIT



40MPHA  
HIGH WALL

**TOSHIBA**  
*Carrier*

Performance  
SERIES

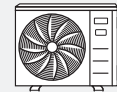

38MA\*R  
OUTDOOR UNIT



40MAQ  
HIGH WALL



40MBDQ  
DUCTED



40MBCQ  
CASSETTE

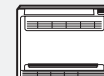

40MBFQ  
CONSOLE

**Comfort**  
SERIES

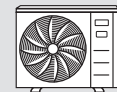

38MHRB  
OUTDOOR UNIT



40MHH  
HIGH WALL



## Multi-zone

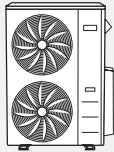

**38VMH-1P**  
HEAT PUMP

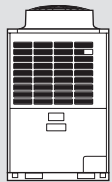

**MMYF-1P**  
HEAT RECOVERY

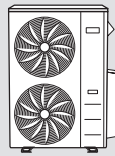

**MCY7-1P**  
HEAT PUMP

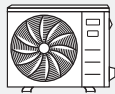

**38MGR**  
OUTDOOR UNIT

## Light Commercial

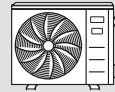

**RAV\*AT**  
OUTDOOR UNIT



**RAV\*KRT**  
HIGH WALL

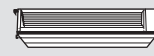

**RAV\*BT**  
DUCTED



**RAV\*UT**  
CASSETTE



**RAV\*CT**  
UNDERCEILING

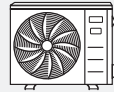

**38MBR**  
OUTDOOR UNIT



**40MBCQ**  
CASSETTE



**40MBDQ**  
DUCTED

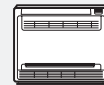

**40MBFQ**  
CONSOLE

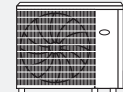

**24AHA4**  
**25HHA4**  
OUTDOOR UNIT





# Single Zone

**INFINITY SERIES**  
38MPRA OUTDOOR UNIT



# Infinity<sup>®</sup> Heat Pump With Basepan Heater

## FEATURES OUTDOOR

- 100% heating capacity at 0°F (-17°C)
- 100% cooling capacity at -22°F (-30°C) without additional kit
- Up to 75% of heating capacity at -22°F (-30°C)
- Available in 208/230V
- Built-in basepan heater
- Auto-restart function
- Refrigerant leakage detection
- Quiet outdoor operation, as low as 55 dB(A)
- Aluminum golden hydrophilic pre-coated fins
- Piping length 98 ft (30m)
- Cooling operating range -22°~122°F (-30°~50°C)
- Heating operating range -22°~86°F (-25°~30°C)

## COMPATIBLE WITH:

- 40MPHA High Wall (p 20)

## Heat Pump With Basepan Heater

Inverter Compressor

Up to 42 SEER

Up to 15 HSPF

Sizes: 09/12

All Systems are ENERGY STAR<sup>®</sup> certified



## KEY FEATURES

### Extra-Low Temperature Heating

Heat output up to 75% of rated capacity down to -22°F (-30°C), so when it's cold outside, it will be warm inside, making this a primary heat source and eliminating the need for a backup heat source.

### Stepless Frequency Adjustment

Precise control maintains stable and constant room temperature while reducing sound level and saving energy.

## High Wall



INFINITY<sup>®</sup> SERIES



**SPECIFICATIONS:**

38MPRA Outdoor Unit			
<b>Heat Pump System</b>			
Size		9	12
Outdoor Model		38MPRAQ09AA3	38MPRAQ12AA3
<b>Electrical</b>			
Voltage, Phase, Cycle	V/Ph/Hz	208/230-1-60	208/230-1-60
MCA	A	13	15
MOCP – Fuse Rating	A	15	20
<b>Operating Range</b>			
Cooling Outdoor DB Min–Max	°F (°C)	-22~122 (-30~50)	-22~122 (-30~50)
Heating Outdoor DB Min–Max	°F (°C)	-22~86 (-30~30)	-22~86 (-30~30)
<b>Piping</b>			
Total Piping Length	ft (m)	98 (30)	98 (30)
Piping Lift*	ft (m)	49 (15)	49 (15)
Pipe Connection Size – Liquid	in (mm)	1/4 (6.35)	1/4 (6.35)
Pipe Connection Size – Suction	in (mm)	3/8 (9.52)	1/2 (12.7)
<b>Refrigerant</b>			
Type		R410A	R410A
Charge	lb (kg)	3.5 (1.58)	3.5 (1.58)
<b>Compressor</b>			
Type		Rotary Inverter	Rotary Inverter
<b>Outdoor</b>			
Unit Width	in (mm)	33.27 (845)	33.27 (845)
Unit Height	in (mm)	27.64 (702)	27.64 (702)
Unit Depth	in (mm)	14.29 (363)	14.29 (363)
Net Weight	lb (kg)	107.59 (48.8)	108.47 (49.2)
Airflow	cfm	1,380	1,380
Sound Pressure	dB(A)	55.5	56.0

\*Condensing unit above or below indoor unit

**COMPATIBILITY:**

Indoor Unit		Outdoor Unit	
		38MPRAQ09AA3	38MPRAQ12AA3
High Wall	40MPHAQ09XA3	•	
	40MPHAQ12XA3		•

High Wall			
Indoor Model		40MPHAQ09XA3	40MPHAQ12XA3
ENERGY STAR®		YES	YES
Cooling System Tons		0.75	1.0
Cooling Rated Capacity	Btu/h	9,000	12,000
Cooling Cap. Range Min–Max	Btu/h	5,000~17,000	5,800~19,000
SEER		42.0	32.0
EER		15.0	13.5
Heating Rated Capacity (47°F)	Btu/h	10,000	12,000
Heating Rated Capacity (17°F)	Btu/h	7,200	6,800
Heating Max Capacity (17°F)	Btu/h	15,690	17,070
Heating Max Capacity (5°F)	Btu/h	13,000	13,800
Heating Cap. Range Min–Max	Btu/h	3,100–19,100	3,500–21,000
HSPF		15.0	14.0
COP (47°F)	W/W	4.00	4.24
COP (17°F)	W/W	2.78	2.64
COP (5°F)	W/W	2.00	2.00

**INFINITY SERIES**  
40MPHA HIGH WALL



# Infinity<sup>®</sup> High Wall Indoor Unit

## FEATURES

- Available in 208/230V
- Modes: Cool, Heat, Dry, Fan, Auto
- Turbo Mode
- Fully modulating fan speeds
- Sleep Mode
- Up-down/right-left louver control (fixed or swing)
- **Relative Humidity Sensor**
- **Occupancy Sensor**
- **Wi-Fi<sup>®</sup> Built-in**
- ECO Mode
- Carbon Filter
- *Follow Me* (senses temperature at handheld remote)
- Heating Setback (46°F Heating Mode)
- Quiet indoor operation, as low as 29 dB(A)
- Aluminum golden hydrophilic pre-coated fins

## COMPATIBLE WITH:

- 38MPRA Outdoor Unit Single Zone (p 18)
- 38MGR Outdoor Unit Multi-zone (p 50)

Sizes: 09/12

## KEY FEATURES

### Relative Humidity Sensor

Increasing comfort customizing the relative humidity in 5% increments in a range of 35%~85%

### Occupancy Sensor

Detects activity in the room and adjusts the horizontal angle of airflow to blow away from people or follow people.

## CONTROLS

Wireless Remote Controller included with indoor unit



Wired Remote Controller KSACN0401AAA (7-Day Programmable) (Optional)



**Optional  
Wired Controller  
(7-Day Programmable)  
KSACN0401AAA**



**Wireless  
Remote  
Controller**

## ACCESSORIES

Condensate Pump (230V optional)

Insulated 25' Line Set

24V Interface for third-party thermostat compatibility (Optional)

## INFINITY SERIES 40MPHA HIGH WALL

### SPECIFICATIONS:

40MPHA High Wall			
<b>Heat Pump System</b>			
Size		9	12
Indoor Model		40MPHAQ09XA3	40MPHAQ12XA3
<b>Electrical</b>			
Voltage, Phase, Cycle	V/Ph/Hz	208/230-1-60	208/230-1-60
Power Supply		Indoor unit powered from outdoor unit	
MCA	A	0.3	0.3
<b>Controls</b>			
Wireless Remote Controller (°F/°C Convertible)		Standard	Standard
Wired Remote Controller (°F/°C Convertible)		Optional	Optional
<b>Operating Range</b>			
Cooling Indoor DB Min–Max	°F (°C)	62~90 (17~32)	62~90 (17~32)
Heating Indoor DB Min–Max	°F (°C)	32~86 (0~30)	32~86 (0~30)
<b>Piping</b>			
Pipe Connection Size – Liquid	in (mm)	1/4 (6.35)	1/4 (6.35)
Pipe Connection Size – Suction	in (mm)	3/8 (9.52)	1/2 (12.7)
<b>Indoor</b>			
Unit Width	in (mm)	35.2 (895)	35.2 (895)
Unit Height	in (mm)	11.7 (298)	11.7 (298)
Unit Depth	in (mm)	9.8 (248)	9.8 (248)
Net Weight	lb (kg)	37.48 (17)	37.48 (17)
Number of Fan Speeds		4	4
Airflow (lowest to highest)	cfm	144/245/295/345	168/252/306/357
Sound Pressure (lowest to highest)	dB(A)	29/35.5/41.5/45.6	29/35.5/41.5/46.8
Air Throw Data	ft (m)	21.98 (6.7)	22.97 (7)
Moisture Removal	Pint/h (L/h)	2.11 (1.0)	2.53 (1.2)
Field Drain Pipe Size O.D.	in (mm)	1 (25.4)	1 (25.4)

Performance may vary based on the compatible outdoor units. See respective pages for performance data.

### COMPATIBILITY:

Indoor Unit	40MPHAQ09XA3	40MPHAQ12XA3
Outdoor Unit Single Zone*	38MPRAQ09AA3	38MPRAQ12AA3
Outdoor Unit Multi-zone*	38MGRQ18B--3 38MGRQ24C--3 38MGRQ30D--3 38MGRQ36D--3 38MGRQ48E--3	



**PERFORMANCE SERIES**  
38MA\*R OUTDOOR UNITS



# Performance™ Heat Pump with Basepan Heater

## FEATURES OUTDOOR

- 100% heating capacity at 5°F (-15°C)  
Sizes 9–24 (208/230V)
- Available in 115V and 208/230V
- Built-in basepan heater
- Auto-restart function
- Condenser high-temperature protection
- Refrigerant leakage detection
- Quiet outdoor operation, as low as 52.5 dB(A)
- Aluminum golden hydrophilic pre-coated fins
- Piping length 82~164 ft (25~50 m)
- Cooling operating range  
-13°~122°F (-25°~50°C)
- Heating operating range  
-22°~86°F (-30°~30°C) –  
Sizes 9–24 (208/230V)  
-13°~86°F (-25°~30°C) – Size 12  
(115V) and 30, 36 (208/230V)

## COMPATIBLE WITH:

- 40MAQ High Wall (p 26)
- 40MBCQ Cassette (p 28)
- 40MBDQ Ducted (p 30)
- 40MBFQ Console (p 32)

## Heat Pump With Basepan Heater

Inverter Compressor

Up to 25 SEER

Up to 12 HSPF

Sizes: 09/12/18/24/30/36

## KEY FEATURES

### Extra-Low Temperature Heating

Heat output up to 69% of rated capacity down to -22°F (-30°C), so when it's cold outside, it will be warm inside, making this a primary heat source and eliminating the need for a backup heat source.

### Rapid Cooling and Heating

After startup, the compressor quickly gets up to maximum speed, cooling or heating the room in minutes.



High Wall



Cassette



Ducted



Floor Console  
Size 12



Console  
Size 18–58

Performance™  
SERIES

**PERFORMANCE SERIES**  
**38MA\*R OUTDOOR UNITS**

**SPECIFICATIONS:**

38MA*R Outdoor Unit								
Heat Pump System								
System								
Size		12	9	12	18	24	30	36
Outdoor Model		38MAQB12R--1	38MAQB09R--3	38MAQB12R--3	38MAQB18R--3	38MAQB24R--3	38MAQB30R--3	38MAQB36R--3
Electrical								
Voltage, Phase, Cycle	V/Ph/Hz	115-1-60	208/230-1-60	208/230-1-60	208/230-1-60	208/230-1-60	208/230-1-60	208/230-1-60
MCA	A	15	9	9	18	20	20	25
MOCP – Fuse Rating	A	20	15	15	25	30	30	35
Operating Range								
Cooling Outdoor DB Min–Max	°F (°C)	-13~122 (-25~50)	-13~122 (-25~50)	-13~122 (-25~50)	-13~122 (-25~50)	-13~122 (-25~50)	-13~122 (-25~50)	-13~122 (-25~50)
Heating Outdoor DB Min–Max	°F (°C)	-13~86 (-25~30)	-22~86 (-30~30)	-22~86 (-30~30)	-22~86 (-30~30)	-22~86 (-30~30)	-13~86 (-25~30)	-13~86 (-25~30)
Piping								
Total Piping Length	ft (m)	82 (25)	82 (25)	82 (25)	98 (30)	98 (30)	164 (50)	164 (50)
Piping Lift*	ft (m)	32 (10)	32 (10)	32 (10)	65 (20)	65 (20)	82 (25)	82 (25)
Pipe Connection Size – Liquid	in (mm)	1/4 (6.35)	1/4 (6.35)	1/4 (6.35)	1/4 (6.35)	3/8 (9.52)	3/8 (9.52)	3/8 (9.52)
Pipe Connection Size – Suction	in (mm)	1/2 (12.7)	3/8 (9.52)	1/2 (12.7)	1/2 (12.7)	5/8 (16)	5/8 (16)	5/8 (16)
Refrigerant								
Type		R410A	R410A	R410A	R410A	R410A	R410A	R410A
Charge	lb (kg)	2.76 (1.25)	3.31 (1.5)	3.31 (1.5)	4.30 (1.95)	5.73 (2.60)	6.06 (2.75)	7.50 (3.40)
Compressor								
Type		Rotary Inverter	Rotary Inverter	Rotary Inverter	Rotary Inverter	Rotary Inverter	Rotary Inverter	Rotary Inverter
Outdoor								
Unit Width	in (mm)	32.09 (815)	32.09 (815)	32.09 (815)	33.66 (855)	37.24 (946)	37.24 (946)	37.24 (946)
Unit Height	in (mm)	21.81 (554)	21.81 (554)	21.81 (554)	27.63 (702)	31.89 (810)	31.89 (810)	31.89 (810)
Unit Depth	in (mm)	13.11 (333)	13.11 (333)	13.11 (333)	14.17 (360)	16.14 (410)	16.14 (410)	16.14 (410)
Net Weight	lb (kg)	82.9 (37.6)	91.5 (41.5)	91.5 (41.5)	118.2 (53.6)	145.5 (66)	139.8 (63.4)	147.3 (66.8)
Airflow	cfm	1,200	1,200	1,200	1,390	2,130	2,130	2,130
Sound Pressure	dB(A)	52.5	55.5	56.0	57.5	60.5	60.5	60.5

\*Condensing unit above or below indoor unit.

**COMPATIBILITY:**

Indoor Unit	Outdoor Unit							
	38MAQB12R--1	38MAQB09R--3	38MAQB12R--3	38MAQB18R--3	38MAQB24R--3	38MAQB30R--3	38MAQB36R--3	
High Wall	40MAQB12B--1	•						
	40MAQB09B--3		•					
	40MAQB12B--3			•				
	40MAQB18B--3				•			
	40MAQB24B--3					•		
	40MAQB30B--3						•	
Cassette	40MBCQ09---3		•					
	40MBCQ12---3			•				
	40MBCQ18---3				•			
	40MBCQ24---3					•		
	40MBCQ36---3						•	
	40MBCQ48---3							
Ducted	40MBDQ09---3		•					
	40MBDQ12---3			•				
	40MBDQ18---3				•			
	40MBDQ24---3					•		
	40MBDQ36---3						•	
	40MBDQ48---3							
	40MBDQ58---3							
Console	40MBFQ12---3			•				
	40MBFQ18---3				•			
	40MBFQ24---3					•		
	40MBFQ36---3						•	
	40MBFQ48---3							
	40MBFQ58---3							

Cassette, Ducted and Console indoor units sizes 36, 48 and 58 ONLY compatible with 38MBR Outdoor Unit.

**PERFORMANCE SERIES**  
38MA<sup>\*</sup>R OUTDOOR UNITS

**PERFORMANCE:**

40MAQ High Wall								
Indoor Model		40MAQB12B--1	40MAQB09B--3	40MAQB12B--3	40MAQB18B--3	40MAQB24B--3	40MAQB30B--3	40MAQB36B--3
<b>ENERGY STAR®</b>		YES	YES	YES	YES	YES	NO	NO
Cooling System Tons		1.0	0.75	1.0	1.4	2.0	2.5	3.0
Cooling Rated Capacity	Btu/h	12,000	9,000	12,000	17,000	24,000	30,000	36,000
Cooling Cap. Range Min–Max	Btu/h	4,000–13,000	3,500–13,000	4,000–13,800	4,500–18,800	5,500–24,500	8,000–30,500	8,000–36,200
SEER		22.0	25.0	22.5	20.0	20.5	19.8	16.0
EER		13	14.5	13	12.5	13	11.5	8.6
Heating Rated Capacity (47°F)	Btu/h	12,000	10,900	12,000	18,000	24,000	30,000	36,000
Heating Rated Capacity (17°F)	Btu/h	7,600	6,900	7,800	10,800	15,400	18,500	21,000
Heating Maximum Capacity (17°F)	Btu/h	7,600	10,900	12,000	18,000	24,000	18,500	21,000
Heating Maximum Capacity (5°F)	Btu/h	6,490	10,900	12,000	18,000	24,000	16,380	16,380
Heating Maximum Capacity (–13°F)	Btu/h	3,800	9,020	9,020	16,520	16,520	14,320	14,320
Heating Cap. Range Min–Max	Btu/h	5,000–13,500	4,500–14,500	5,000–15,500	5,500–24,000	6,000–32,000	9,000–34,000	9,000–37,000
HSPF		10.2	11.2	12.0	10.3	11.5	9.4	8.5
COP (47°F)	W/W	3.40	3.80	3.56	3.14	3.10	2.60	2.56
COP (17°F)	W/W	2.60	2.74	2.64	2.64	2.64	2.16	2.12
COP (5°F)	W/W	1.94	1.98	1.98	1.63	1.77	2.20	1.50

**PERFORMANCE:**

40MBCQ Cassette					
Indoor Model		40MBCQ09---3	40MBCQ12---3	40MBCQ18---3	40MBCQ24---3
<b>ENERGY STAR®</b>		YES	YES	YES	NO
Cooling System Tons		0.75	1.0	1.3	2.0
Cooling Rated Capacity	Btu/h	9,000	12,000	16,000	24,000
Cooling Cap. Range Min–Max	Btu/h	3,500–11,000	4,000–13,000	4,500–18,000	8,500–26,500
SEER		20.0	19.5	20.0	20.0
EER		13.0	12.5	12.5	11.0
Heating Rated Capacity (47°F)	Btu/h	10,000	12,000	18,000	24,000
Heating Rated Capacity (17°F)	Btu/h	6,700	8,700	12,000	16,200
Heating Maximum Capacity (17°F)	Btu/h	9,000	12,000	18,000	24,000
Heating Maximum Capacity (5°F)	Btu/h	9,000	12,000	18,000	24,000
Heating Maximum Capacity (–13°F)	Btu/h	7,320	7,540	12,590	18,500
Heating Cap. Range Min–Max	Btu/h	4,500–11,500	5,000–13,500	5,500–19,000	13,200–32,000
HSPF		10.8	10.6	10.5	11.5
COP (47°F)	W/W	3.30	3.67	3.43	3.46
COP (17°F)	W/W	2.37	2.40	2.55	2.73
COP (5°F)	W/W	1.62	1.62	1.75	1.88



**PERFORMANCE SERIES**  
38MA\*R OUTDOOR UNITS

**PERFORMANCE:**

40MBDQ Ducted					
Indoor Model		40MBDQ09---3	40MBDQ12---3	40MBDQ18---3	40MBDQ24---3
<b>ENERGY STAR®</b>		YES	YES	YES	YES
Cooling System Tons		0.75	1.0	1.4	2.0
Cooling Rated Capacity	Btu/h	9,000	12,000	16,500	24,000
Cooling Cap. Range Min-Max	Btu/h	3,500~12,000	4,000~12,900	4,500~18,000	5,500~24,500
SEER		23.0	20.5	19.6	20.5
EER		13.5	12.5	12.5	12.5
Heating Rated Capacity (47°F)	Btu/h	10,000	12,000	19,000	24,000
Heating Rated Capacity (17°F)	Btu/h	7,200	8,500	13,400	17,200
Heating Maximum Capacity (17°F)	Btu/h	10,000	13,000	20,200	25,400
Heating Maximum Capacity (5°F)	Btu/h	10,000	12,000	19,000	24,000
Heating Maximum Capacity (-13°F)	Btu/h	8,350	8,560	12,510	16,520
Heating Cap. Range Min-Max	Btu/h	4,000~15,000	4,500~15,700	5,500~19,000	6,000~26,000
HSPF		12.0	11.0	11.0	12.5
COP (47°F)	W/W	3.60	3.30	2.93	3.82
COP (17°F)	W/W	2.92	2.36	2.71	2.56
COP (5°F)	W/W	1.91	1.79	1.75	1.83

**PERFORMANCE:**

40MBFQ Console				
Indoor Model		40MBFQ12---3	40MBFQ18---3	40MBFQ24---3
<b>ENERGY STAR®</b>		YES	YES	NO
Cooling System Tons		1.0	1.4	2.0
Cooling Rated Capacity	Btu/h	12,000	17,000	24,000
Cooling Cap. Range Min-Max	Btu/h	4,000~13,000	6,830~19,800	8,000~28,150
SEER		19.4	19.9	20.0
EER		12.5	12.5	11.5
Heating Rated Capacity (47°F)	Btu/h	12,000	18,000	24,000
Heating Rated Capacity (17°F)	Btu/h	9,600	13,400	17,200
Heating Maximum Capacity (17°F)	Btu/h	12,000	21,500	26,600
Heating Maximum Capacity (5°F)	Btu/h	12,000	21,300	26,560
Heating Maximum Capacity (-13°F)	Btu/h	8,150	15,670	18,540
Heating Cap. Range Min-Max	Btu/h	5,000~13,500	12,900~29,000	20,500~36,750
HSPF		10.5	10.6	11.5
COP (47°F)	W/W	3.17	3.48	3.52
COP (17°F)	W/W	2.49	2.38	2.82
COP (5°F)	W/W	1.49	1.66	1.69

**PERFORMANCE SERIES**  
40MAQ HIGH WALL



# Performance™ High Wall Indoor Unit

## FEATURES

- Available in 115V and 208/230V
- Modes: Cool, Heat, Dry, Fan, Auto
- Turbo Mode
- Four fan speeds
- Sleep Mode
- Up-down louver control (fixed or swing)
- *Follow Me* (senses temperature at handheld remote)
- Heating Setback (46°F Heating Mode)
- Quiet indoor operation, as low as 27 dB(A)
- Aluminum golden hydrophilic pre-coated fins

## COMPATIBLE WITH:

- 38MA\*R Outdoor Unit Single Zone (p 22)
- 38MGR Outdoor Unit Multi-zone (p 50)

## ACCESSORIES

Condensate Pump  
53DS-900---117 (115V)  
53DS-900---118 (208/230V)

Insulated 25' Line Set

24V Interface for third-party thermostat compatibility\*\*

\*\*Compatible with indoor units starting with Serial Number 4216V10001.

Performance™  
SERIES

Sizes: 09/12/18/24/30/36

## KEY FEATURES

### *Follow Me*

Temperature sensor built in the remote controller will sense its surrounding temperature. The unit will adjust the room temperature more accurately to give you comfort.

## CONTROLS

Wireless Remote Controller included with indoor unit



Wired Remote Controller KSACN0101AAA (Timer Function) (Optional)

Wired Remote Controller KSACN0401AAA (7-Day Programmable) (Optional)\*

\*7-Day Programmable compatible with indoor units starting with Serial Number 0216V10001.



**Standard Wired Controller  
(Timer Function)  
KSACN0101AAA**



**Optional Wired Controller  
(7-Day Programmable)  
KSACN0401AAA**



**Wireless  
Remote Controller**

# PERFORMANCE SERIES 40MAQ HIGH WALL

## SPECIFICATIONS:

40MAQ High Wall								
Heat Pump								
System								
Size		12	9	12	18	24	30	36
Indoor Model		40MAQB12B--1	40MAQB09B--3	40MAQB12B--3	40MAQB18B--3	40MAQB24B--3	40MAQB30B--3	40MAQB36B--3
Electrical								
Voltage, Phase, Cycle	V/Ph/Hz	115-1-60	208/230-1-60	208/230-1-60	208/230-1-60	208/230-1-60	208/230-1-60	208/230-1-60
Power Supply	Indoor unit powered from outdoor unit							
MCA	A	0.4	0.2	0.2	0.27	0.4	0.4	0.4
Controls								
Wireless Remote Controller (°F/°C Convertible)		Standard	Standard	Standard	Standard	Standard	Standard	Standard
Wired Remote Controller (°F/°C Convertible)		Optional	Optional	Optional	Optional	Optional	Optional	Optional
Operating Range								
Cooling Outdoor DB Min–Max	°F (°C)	63~86 (17~30)	63~86 (17~30)	63~86 (17~30)	63~86 (17~30)	63~86 (17~30)	63~86 (17~30)	63~86 (17~30)
Heating Outdoor DB Min–Max	°F (°C)	32~86 (0~30)	32~86 (0~30)	32~86 (0~30)	32~86 (0~30)	32~86 (0~30)	32~86 (0~30)	32~86 (0~30)
Piping								
Pipe Connection Size – Liquid	in (mm)	1/4 (6.35)	1/4 (6.35)	1/4 (6.35)	1/4 (6.35)	3/8 (9.52)	3/8 (9.52)	3/8 (9.52)
Pipe Connection Size – Suction	in (mm)	1/2 (12.7)	3/8 (9.52)	1/2 (12.7)	1/2 (12.7)	5/8 (16)	5/8 (16)	5/8 (16)
Indoor								
Unit Width	in (mm)	32.87 (835)	32.87 (835)	32.87 (835)	38.98 (990)	46.69 (1,186)	46.69 (1,186)	46.69 (1,186)
Unit Height	in (mm)	11.02 (280)	11.02 (280)	11.02 (280)	12.40 (315)	13.39 (343)	13.39 (343)	13.39 (343)
Unit Depth	in (mm)	7.80 (198)	7.80 (198)	7.80 (198)	8.58 (218)	10.16 (258)	10.16 (258)	10.16 (258)
Net Weight	lb (kg)	19.18 (8.7)	19.18 (8.7)	19.18 (8.7)	26.46 (12.0)	40.12 (18.2)	40.12 (18.2)	40.12 (18.2)
Number of Fan Speeds		4	4	4	4	4	4	4
Airflow (lowest to highest)	cfm	210/300/360/380	210/290/360/380	210/300/360/380	310/450/650/680	520/620/780/870	520/620/780/870	520/620/780/870
Sound Pressure (lowest to highest)	dB(A)	27/34/42	27/34/42	27/34/42	33/40/46	39/45/50	39/45/50	39/45/50
Air Throw Data	ft (m)	23 (7)	23 (7)	23 (7)	30 (9)	36 (11)	36 (11)	36 (11)
Moisture Removal	Pint/h (L/h)	2.8 (1.3)	1.1 (0.5)	2.3 (1.1)	3.8 (1.8)	5.4 (2.6)	8.1 (3.9)	11.7 (5.6)
Field Drain Pipe Size O.D.	in (mm)	0.625 (16)	0.625 (16)	0.625 (16)	0.625 (16)	0.625 (16)	0.625 (16)	0.625 (16)

Performance may vary based on the compatible outdoor units. See respective pages for performance data.

## COMPATIBILITY:

Indoor Unit	40MAQB12B--1	40MAQB09B--3	40MAQB12B--3	40MAQB18B--3	40MAQB24B--3	40MAQB30B--3	40MAQB36B--3
Outdoor Unit Single Zone	38MAQB12R--1	38MAQB09R--3	38MAQB12R--3	38MAQB18R--3	38MAQB24R--3	38MAQB30R--3	38MAQB36R--3
Outdoor Unit Multi-zone	38MGRQ18B--3						
	38MGRQ24C--3						
	38MGRQ30D--3						
	38MGRQ36D--3						
	38MGRQ48E--3						

Backward compatible with 38MAQ Single Zone and 38MGQ Multi-zone Systems





# Performance™ Cassette Indoor Unit

## FEATURES

- Modes: Cool, Heat, Dry, Fan, Auto
- Auto-restart function
- Louver control (fixed or swing)
- Three fan speeds
- Outside air intake
- Built-in condensate lift pump
- *Follow Me* (senses temperature at handheld remote)
- Heating Setback (46°F Heating Mode)
- Quiet indoor operation, as low as 34 dB(A)
- Aluminum golden hydrophilic pre-coated fins
- Grille/ceiling panel 2" x 2" sizes 9 to 18 40MBCQ01XXX3
- Grille/ceiling panel 3" x 3" size 24 P/N 40MBCQ02XXX3

## COMPATIBLE WITH:

- 38MA\*R Outdoor Unit Single Zone (p 22)
- 38MGR Outdoor Unit Multi-zone (p 50)

Performance™  
SERIES

Sizes: 09/12/18/24

## KEY FEATURES

### Built-in Condensate Lift Pump

The cassette is supplied with a condensate lift pump that is capable of lifting the water 29.5in (750mm) above the top of the unit.

### Integrated Electrical Components

Easy maintenance with the circuit box right inside the unit. The integrated design provides a more compact size for easier installation.

## CONTROLS

Wireless Remote Controller included with indoor unit



Optional Wired Remote Controller KSACN0101AAA (Timer Function)

Optional Wired Remote Controller KSACN0501AAA (7-Day Programmable)



Optional  
Wired Controller  
(Timer Function)  
KSACN0101AAA



Optional  
Wired Controller  
(7-Day Programmable)  
KSACN0501AAA



Wireless  
Remote  
Controller

## ACCESSORIES

Wi-Fi® Kit

Grille is required; sold separately.

**PERFORMANCE SERIES**  
**40MBCQ CASSETTE**

**SPECIFICATIONS:**

40MBCQ Cassette					
Heat Pump System					
Size		9	12	18	24
Indoor Model		40MBCQ09---3	40MBCQ12---3	40MBCQ18---3	40MBCQ24---3
Electrical					
Voltage, Phase, Cycle	V/Ph/Hz	208/230-1-60	208/230-1-60	208/230-1-60	208/230-1-60
Power Supply		Indoor unit powered from outdoor unit			
MCA	A	0.2	0.2	0.2	0.3
Controls					
Wireless Remote Controller (°F/°C Convertible)		Standard	Standard	Standard	Standard
Wired Remote Controller (°F/°C Convertible)		Optional	Optional	Optional	Optional
Operating Range					
Cooling Indoor DB Min–Max	°F (°C)	63~90 (17~32)	63~90 (17~32)	63~90 (17~32)	62~90 (17~32)
Heating Indoor DB Min–Max	°F (°C)	32~86 (0~30)	32~86 (0~30)	32~86 (0~30)	32~86 (0~30)
Piping					
Pipe Connection Size – Liquid	in (mm)	1/4 (6.35)	1/4 (6.35)	1/4 (6.35)	3/8 (9.52)
Pipe Connection Size – Suction	in (mm)	3/8 (9.52)	1/2 (12.7)	1/2 (12.7)	5/8 (16)
Indoor					
Body Unit Width	in (mm)	22.44 (570)	22.44 (570)	22.44 (570)	33.07 (840)
Body Unit Height	in (mm)	10.24 (260)	10.24 (260)	10.24 (260)	8.07 (205)
Body Unit Depth	in (mm)	22.44 (570)	22.44 (570)	22.44 (570)	33.07 (840)
Body Net Weight	lb (kg)	35.27 (16)	35.27 (16)	39.68 (18)	46.3 (21)
Panel Unit Width	in (mm)	25.47 (647)	25.47 (647)	25.47 (647)	37.4 (950)
Panel Unit Height	in (mm)	1.97 (50)	1.97 (50)	1.97 (50)	2.17 (55)
Panel Unit Depth	in (mm)	25.47 (647)	25.47 (647)	25.47 (647)	37.4 (950)
Panel Net Weight	lb (kg)	5.51 (2.5)	5.51 (2.5)	5.51 (2.5)	11.02 (5)
Number of Fan Speeds		3	3	3	3
Airflow (lowest to highest)	cfm	260/320/380	280/340/400	290/350/420	625/761/878
Sound Pressure (lowest to highest)	dB(A)	34/39/44	36/39/42	46/48/50	47/50/52
Air Throw Data	ft (m)	23 (7)	23 (7)	30 (9)	30 (9)
Moisture Removal	Pint/h (L/h)	1.58 (0.75)	2.88 (1.366)	4.26 (2.02)	5.22 (2.47)
Field Drain Pipe Size O.D.	in (mm)	1 (25.4)	1 (25.4)	1 (25.4)	1 (25.4)

Performance may vary based on the compatible outdoor units. See respective pages for performance data.

**COMPATIBILITY:**

Indoor Unit	40MBCQ09---3	40MBCQ12---3	40MBCQ18---3	40MBCQ24---3
Outdoor Unit Single Zone	38MAQB09R--3	38MAQB12R--3	38MAQB18R--3	38MAQB24R--3
Outdoor Unit Multi-zone	38MGRQ18B--3			
	38MGRQ24C--3			
			38MGRQ30D--3	
			38MGRQ36D--3	
			38MGRQ48E--3	

Backward compatible with 38MAQ Single Zone and 38MGQ Multi-zone Systems

PERFORMANCE SERIES  
40MBDQ DUCTED

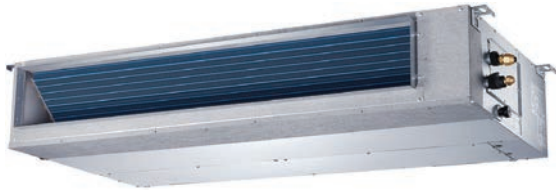

# Performance™ Ducted Indoor Unit

## FEATURES

- Modes: Cool, Heat, Dry, Fan, Auto
- Vertical or horizontal installation
- Up to 0.64 in WG
- Rear or bottom return
- Outside air intake
- *Follow Me* (senses temperature at handheld remote)
- Heating Setback (46°F Heating Mode)
- Quiet indoor operation, as low as 30 dB(A)
- Aluminum golden hydrophilic pre-coated fins
- External condensate lift pump shipped with the unit (sizes 09–18)
- Built-in condensate lift pump (size 24)

## COMPATIBLE WITH:

- 38MA\*R Outdoor Unit Single Zone (p 22)
- 38MGR Outdoor Unit Multi-zone (p 50)

Performance™  
SERIES

Sizes: 09/12/18/24

## KEY FEATURES

### Vertical or Horizontal Installation

Designed for maximum installation flexibility. The secondary drain built-in allows the unit to be mounted vertically allowing either a floor or ceiling-concealed installation depending on existing conditions.

### Flexible Air Intake

Air inlet can be installed either at the back or the bottom of the unit due to the small plate size on the flange, allowing for flexible installation to meet the needs of each job.

## CONTROLS

Wireless Remote Controller included with indoor unit



Optional Wired Remote Controller (Timer Function)

Wired Remote Controller KSACN0501AAA (7-Day Programmable) included with indoor unit



Optional  
Wired Controller  
(Timer Function)  
KSACN0101AAA



Optional  
Wired Controller  
(7-Day Programmable)  
KSACN0501AAA



Wireless  
Remote  
Controller

## ACCESSORIES

24V Interface for third-party thermostat compatibility

Wi-Fi® Kit



**PERFORMANCE SERIES**  
40MBDQ DUCTED

**SPECIFICATIONS:**

40MBDQ Ducted					
Heat Pump System					
Size		9	12	18	24
Indoor Model		40MBDQ09---3	40MBDQ12---3	40MBDQ18---3	40MBDQ24---3
Electrical					
Voltage, Phase, Cycle	V/Ph/Hz	208/230-1-60	208/230-1-60	208/230-1-60	208/230-1-60
Power Supply		Indoor unit powered from outdoor unit			
MCA	A	1.11	1.11	1.2	1.2
Controls					
Wireless Remote Controller (°F/°C Convertible)		Standard	Standard	Standard	Standard
Wired Remote Controller (°F/°C Convertible)		Standard	Standard	Standard	Standard
Operating Range					
Cooling Indoor DB Min–Max	°F (°C)	63~90 (17~32)	63~90 (17~32)	63~90 (17~32)	63~90 (17~32)
Heating Indoor DB Min–Max	°F (°C)	32~86 (0~30)	32~86 (0~30)	32~86 (0~30)	32~86 (0~30)
Piping					
Pipe Connection Size – Liquid	in (mm)	1/4 (6.35)	1/4 (6.35)	1/4 (6.35)	3/8 (9.52)
Pipe Connection Size – Suction	in (mm)	3/8 (9.52)	1/2 (12.7)	1/2 (12.7)	5/8 (16)
Indoor					
Unit Width	in (mm)	27.56 (700)	27.56 (700)	34.65 (880)	43.31 (1100)
Unit Height	in (mm)	7.87 (200)	7.87 (200)	8.27 (210)	9.8 (249)
Unit Depth	in (mm)	19.92 (506)	19.92 (506)	26.54 (674)	30.47 (774)
Net Weight	lb (kg)	43.56 (19.8)	43.56 (19.8)	54 (24.5)	86.86 (39.4)
Number of Fan Speeds		3	3	3	3
Airflow (lowest to highest)	cfm	147/211/264	176/282/353	300/400/480	440/700/780
Sound Pressure (lowest to highest)	dB(A)	30/34/38	35/37/39	35/37/39	35.5/40/44
Max Static Pressure	in WG	0.20	0.20	0.40	0.64
Field Drain Pipe Size O.D.	in (mm)	1 (25.4)	1 (25.4)	1 (25.4)	1 (25.4)

Performance may vary based on the compatible outdoor units. See respective pages for performance data.

**COMPATIBILITY:**

Indoor Unit	40MBDQ09---3	40MBDQ12---3	40MBDQ18---3	40MBDQ24---3
Outdoor Unit Single Zone	38MAQB09R--3	38MAQB12R--3	38MAQB18R--3	38MAQB24R--3
Outdoor Unit Multi-zone	38MGRQ18B--3			
	38MGRQ24C--3			
	38MGRQ30D--3			
	38MGRQ36D--3			
	38MGRQ48E--3			

For Sizes 36 and 48, refer to the Light Commercial Section  
Backward compatible with 38MAQ Single Zone and 38MGQ Multi-zone Systems

PERFORMANCE SERIES  
40MBFQ CONSOLE



Floor Console  
Size 12

Console  
Size 18-58

# Performance™ Floor Console Indoor Unit

## FEATURES

- Modes: Cool, Heat, Dry, Fan, Auto
- Auto-restart function
- Louver control (fixed or swing)
- Three fan speeds
- Air discharge from top and bottom (size 12)
- *Follow Me* (senses temperature at handheld remote)
- Heating Setback (46°F Heating Mode)
- Quiet indoor operation, as low as 37 dB(A)
- Aluminum golden hydrophilic pre-coated fins

## COMPATIBLE WITH:

- 38MA\*R Outdoor Unit Single Zone (p 22)
- 38MGR Outdoor Unit Multi-zone (p 50)

Performance™  
SERIES

Sizes: 12/18/24

## KEY FEATURES

### 2-Way Optional Air Outlet

Both up and down air-outlet or up air-outlet only. (Size 12 only.)

### Outside Air Intake

Outside air is brought into the room via a connection pipe, which keeps the indoor air fresher and cleaner. (Sizes 18 to 24 only.)

## CONTROLS

Wireless Remote Controller included with indoor unit



Optional Wired Remote Controller KSACN0101AAA (Timer Function)

Optional Wired Remote Controller KSACN0401AAA (7-Day Programmable) Size 12

Optional Wired Remote Controller KSACN0501AAA (7-Day Programmable) Sizes 18 and 24



Optional  
Wired Controller  
(Timer Function)  
KSACN0101AAA



Optional  
Wired Controller  
(7-Day Programmable)  
KSACN0401AAA or  
KSACN0501AAA



Wireless  
Remote  
Controller

**SPECIFICATIONS:**

40MBFQ Console				
Heat Pump System				
Size		12	18	24
Indoor Model		40MBFQ12---3	40MBFQ18---3	40MBFQ24---3
Electrical				
Voltage, Phase, Cycle	V/Ph/Hz	208/230-1-60	208/230-1-60	208/230-1-60
Power Supply		Indoor unit powered from outdoor unit		
MCA	A	0.29	1.0	1.0
Controls				
Wireless Remote Controller (°F/°C Convertible)			Standard	
Wired Remote Controller (°F/°C Convertible)			Optional	
Operating Range				
Cooling Indoor DB Min–Max	°F (°C)	63~90 (17~32)	62~90 (17~32)	62~90 (17~32)
Heating Indoor DB Min–Max	°F (°C)	32~86 (0~30)	32~86 (0~30)	32~86 (0~30)
Piping				
Pipe Connection Size – Liquid	in (mm)	1/4 (6.35)	1/4 (6.35)	3/8 (9.52)
Pipe Connection Size – Suction	in (mm)	1/2 (12.7)	1/2 (12.7)	5/8 (16)
Indoor				
Unit Width	in (mm)	27.56 (700)	42.05 (1,068)	42.05 (1,068)
Unit Height	in (mm)	23.62 (600)	26.57 (675)	26.57 (675)
Unit Depth	in (mm)	8.27 (210)	9.25 (235)	9.25 (235)
Net Weight	lb (kg)	32.41 (14.7)	55.12 (25)	58.42 (26.5)
Number of Fan Speeds		3	3	3
Airflow (lowest to highest)	cfm	220/250/280	420/485/550	600/710/760
Sound Pressure (lowest to highest)	dB(A)	34/41/45	39/44/47	46/50/52
Air Throw Data	ft (m)	23 (7)	26 (8)	26 (8)
Field Drain Pipe Size O.D.	in (mm)	1 (25.4)	1 (25.4)	1 (25.4)

Performance may vary based on the compatible outdoor units. See respective pages for performance data.

**COMPATIBILITY:**

Indoor Unit	40MBFQ12---3	40MBFQ18---3	40MBFQ24---3
Outdoor Unit Single Zone	38MAQB12R--3	38MAQB18R--3	38MAQB24R--3
Outdoor Unit Multi-zone	38MGRQ18B--3		
	38MGRQ24C--3		
		38MGRQ30D--3	
		38MGRQ36D--3	
		38MGRQ48E--3	

Backward compatible with 38MAQ Single Zone and 38MGQ Multi-zone Systems



**COMFORT SERIES**  
38MHRB OUTDOOR UNIT



# Comfort™ Heat Pump

## FEATURES OUTDOOR

- Cost competitive
- Available in 115V and 208/230V
- Built-in basepan heater on heat pump units
- Auto-restart function
- Refrigerant leakage detection
- Quiet outdoor operation, as low as 52 dB(A)
- Aluminum golden hydrophilic pre-coated fins
- Piping length 82~164 ft (25~50m)
- Cooling operating range 0°~122°F (-17°~50°C)
- Heating operating range 0°~86°F (-17°~30°C)

## COMPATIBLE WITH:

- 40MHHC High Wall Cooling Only (p 38)
- 40MHHQ High Wall Heat Pump (p 40)

## Cooling Only – 38MHRBC Heat Pump – 38MHRBQ With Basepan Heater

Inverter Compressor  
Up to 19.8 SEER  
Up to 10.6 HSPF  
Sizes: 09/12/18/24

## KEY FEATURES

### Economical Solution

An economical choice that can provide comfort when you need it.

### Rapid Cooling and Heating

After startup, the compressor quickly gets up to maximum speed, cooling or heating the room in minutes.



High Wall

**Comfort™**  
S E R I E S

**COMFORT SERIES**  
38MHRB OUTDOOR UNIT

**SPECIFICATIONS:**

38MHRB Outdoor Unit						
Heat Pump System						
Size		12	9	12	18	24
Outdoor Model		38MHRBQ12AA1	38MHRBQ09AA3	38MHRBQ12AA3	38MHRBQ18AA3	38MHRBQ24AA3
Electrical						
Voltage, Phase, Cycle	V/Ph/Hz	115-1-60	208/230-1-60	208/230-1-60	208/230-1-60	208/230-1-60
MCA	A	13	8	10	15	18
MOCP – Fuse Rating	A	20	15	15	20	25
Operating Range						
Cooling Outdoor DB Min–Max	°F (°C)	0~122 (-17~50)	0~122 (-17~50)	0~122 (-17~50)	0~122 (-17~50)	0~122 (-17~50)
Heating Outdoor DB Min–Max	°F (°C)	0~86 (-17~30)	0~86 (-17~30)	0~86 (-17~30)	0~86 (-17~30)	0~86 (-17~30)
Piping						
Total Piping Length	ft (m)	82 (25)	82 (25)	82 (25)	98 (30)	164 (50)
Piping Lift*	ft (m)	33 (10)	33 (10)	33 (10)	66 (20)	66 (20)
Pipe Connection Size – Liquid	in (mm)	1/4 (6.35)	1/4 (6.35)	1/4 (6.35)	1/4 (6.35)	3/8 (9.52)
Pipe Connection Size – Suction	in (mm)	1/2 (12.7)	3/8 (9.52)	1/2 (12.7)	1/2 (12.7)	5/8 (16)
Refrigerant						
Type		R410A	R410A	R410A	R410A	R410A
Charge	lb (kg)	2.12 (0.96)	1.76 (0.80)	2.12 (0.96)	2.82 (1.28)	3.97 (1.80)
Compressor						
Type		Rotary Inverter	Rotary Inverter	Rotary Inverter	Rotary Inverter	Rotary Inverter
Outdoor						
Unit Width	in (mm)	30.31 (770)	30.31 (770)	30.31 (770)	31.50 (800)	33.27 (845)
Unit Height	in (mm)	21.85 (555)	21.85 (555)	21.85 (555)	21.81 (554)	27.64 (702)
Unit Depth	in (mm)	11.81 (300)	11.81 (300)	11.81 (300)	13.11 (333)	14.29 (363)
Net Weight	lb (kg)	69 (31.3)	63 (28.6)	65.5 (29.7)	79.6 (36.1)	114.2 (51.8)
Airflow	cfm	1,170	1,170	1,170	1,170	1,765
Sound Pressure	dB(A)	54.5	57.2	57.4	57.0	60.2

\*Condensing unit above or below indoor units.

**COMPATIBILITY:**

Indoor Unit		Outdoor Unit				
		38MHRBQ12AA1	38MHRBQ09AA3	38MHRBQ12AA3	38MHRBQ18AA3	38MHRBQ24AA3
High Wall	40MHHQ12---1	•				
	40MHHQ09---3		•			
	40MHHQ12---3			•		
	40MHHQ18---3				•	
	40MHHQ24---3					•

Manufacturer reserves the right to discontinue, or change at any time, specification or designs without notice or incurring obligations.

**COMFORT SERIES**  
38MHRB OUTDOOR UNIT

**PERFORMANCE:**

40MHHQ High Wall						
Heat Pump						
Indoor Unit		40MHHQ12---1	40MHHQ09---3	40MHHQ12---3	40MHHQ18---3	40MHHQ24---3
<b>ENERGY STAR®</b>		<b>NO</b>	<b>NO</b>	<b>NO</b>	<b>NO</b>	<b>NO</b>
Cooling System Tons		1.0	0.8	1.0	1.5	2.0
Cooling Rated Capacity	Btu/h	12,000	9,000	12,000	18,000	24,000
Cooling Cap. Range Min–Max	Btu/h	3,700~13,000	3,400~10,500	3,700~13,000	5,500~19,000	8,987~26,585
SEER		19.8	18.5	19.8	19.0	17.3
EER		10	11.2	11.2	11.2	9.7
Heating Rated Capacity (47°F)	Btu/h	12,000	9,800	12,000	18,000	24,800
Heating Rated Capacity (17°F)	Btu/h	8,000	7,500	9,230	11,600	18,000
Heating Maximum Capacity (17°F)	Btu/h	8,200	7,850	9,500	11,800	18,300
Heating Maximum Capacity (5°F)	Btu/h	9,000	6,070	8,880	10,150	16,760
Heating Cap. Range Min–Max	Btu/h	3,500~13,500	2,800~11,500	3,500~13,500	6,200~19,000	8,371~25,350
HSPF		10.6	10.0	9.6	10.6	9.6
COP (47°F)	W/W	2.93	3.27	3.22	3.26	3.13
COP (17°F)	W/W	2.58	2.58	2.64	2.64	2.49
COP (5°F)	W/W	1.60	1.60	1.60	1.50	1.40

**PERFORMANCE:**

40MHHC High Wall					
Cooling Only					
Indoor Unit		40MHHC12---1	40MHHC12---3	40MHHC18---3	40MHHC24---3
<b>ENERGY STAR®</b>		<b>NO</b>	<b>NO</b>	<b>NO</b>	<b>NO</b>
Cooling System Tons		1.0	1.0	1.4	1.8
Cooling Rated Capacity	Btu/h	12,000	11,500	17,000	22,000
Cooling Cap. Range Min–Max	Btu/h	4,800~13,200	4,800~13,000	5,800~18,600	4,900~24,100
SEER		17.3	19.0	19.0	18.5
EER		10.7	11.2	10.3	11.1



**COMFORT SERIES**  
38MHRB OUTDOOR UNIT

**SPECIFICATIONS:**

38MHRB Outdoor Unit					
Cooling Only					
System					
Size		12	12	18	24
Outdoor Model		38MHRBC12AA1	38MHRBC12AA3	38MHRBC18AA3	38MHRBC24AA3
Electrical					
Voltage, Phase, Cycle	V/Ph/Hz	115-1-60	208/230-1-60	208/230-1-60	208/230-1-60
MCA	A	13	11	15	18
MOCP – Fuse Rating	A	20	15	20	25
Operating Range					
Cooling Outdoor DB Min–Max	°F (°C)	0~122 (–17~50)	0~122 (–17~50)	0~122 (–17~50)	0~122 (–17~50)
Piping					
Total Piping Length	ft (m)	82 (25)	82 (25)	98 (30)	164 (50)
Piping Lift*	ft (m)	33 (10)	33 (10)	66 (20)	66 (20)
Pipe Connection Size – Liquid	in (mm)	1/4 (6.35)	1/4 (6.35)	1/4 (6.35)	3/8 (9.52)
Pipe Connection Size – Suction	in (mm)	1/2 (12.7)	1/2 (12.7)	1/2 (12.7)	5/8 (16)
Refrigerant					
Type		R410A	R410A	R410A	R410A
Charge	lb (kg)	1.30 (0.59)	1.17 (0.53)	1.98 (0.90)	2.56 (1.16)
Compressor					
Type		Rotary Inverter	Rotary Inverter	Rotary Inverter	Rotary Inverter
Outdoor					
Unit Width	in (mm)	30.31 (770)	30.31 (770)	30.31 (770)	33.27 (845)
Unit Height	in (mm)	21.85 (555)	21.85 (555)	21.85 (555)	27.64 (702)
Unit Depth	in (mm)	11.81 (300)	11.81 (300)	11.81 (300)	14.29 (363)
Net Weight	lb (kg)	57.8 (26.2)	53.8 (24.4)	65.9 (29.9)	88.6 (40.2)
Airflow	cfm	1,170	1,230	1,195	1,825
Sound Pressure	dB(A)	52.0	53.6	55.3	58.0

\*Condensing unit above or below indoor units.

**COMPATIBILITY:**

Indoor Unit		Outdoor Unit			
		38MHRBC12AA1	38MHRBC12AA3	38MHRBC18AA3	38MHRBC24AA3
High Wall	40MHHC12---1	•			
	40MHHC12---3		•		
	40MHHC18---3			•	
	40MHHC24---3				•

**COMFORT SERIES**  
40MHH HIGH WALL



# Comfort™ High Wall Indoor Unit

## FEATURES

- Available in 115V and 208/230V
- Modes: Cool, Heat, Dry, Fan, Auto
- Turbo Mode
- Up-down louver control (fixed or swing)
- **Filter removal from the top**
- **Improved serviceability**
- Four fan speeds
- Sleep Mode
- *Follow Me* (senses temperature at handheld remote)
- Heating Setback (46°F Heating Mode)
- Quiet indoor operation, as low as 27 dB(A)
- Aluminum golden hydrophilic pre-coated fins

## COMPATIBLE WITH:

- 38MHRB Outdoor Unit Single Zone (p 34)
- 38MGR Outdoor Unit Multi-zone (p 50)

**Comfort**  
SERIES

**Cooling Only – 40MHHC**  
**Heat Pump – 40MHHQ**

Sizes: 09/12/18/24

## KEY FEATURES

### Improved Serviceability

Full access to the terminal connections and fan after lifting the front cover of the high wall for easy installation and service.

### Convenient Filter Removal

The filter is conveniently located on the inlet, allowing direct removal from the top of the unit without opening the panel.

## CONTROLS

Wireless Remote Controller included with indoor unit



Optional Wired Remote Controller (7-Day Programmable)



**Optional  
Wired Controller  
(7-Day Programmable)**  
KSACN0401AAA



**Wireless  
Remote  
Controller**

## ACCESSORIES

Condensate Pump  
53DS-900---117 (115V)  
53DS-900---118 (208/230V) – (optional)

Insulated 25' Line Set

24V Interface for third-party thermostat compatibility

**COMFORT SERIES**  
40MHH HIGH WALL

**SPECIFICATIONS:**

40MHH High Wall					
Cooling Only System					
Size		12	12	18	24
Indoor Model		40MHHC12---1	40MHHC12---3	40MHHC18---3	40MHHC24---3
Electrical					
Voltage, Phase, Cycle	V/Ph/Hz	115-1-60	208/230-1-60	208/230-1-60	208/230-1-60
Power Supply		Indoor unit powered from outdoor unit			
MCA	A	0.3	0.25	0.4	0.45
Controls					
Wireless Remote Controller (°F/°C Convertible)		Standard	Standard	Standard	Standard
Wired Remote Controller (°F/°C Convertible)		Optional	Optional	Optional	Optional
Operating Range					
Cooling Indoor DB Min–Max	°F (°C)	63~90 (17~32)	63~90 (17~32)	63~90 (17~32)	63~90 (17~32)
Piping					
Pipe Connection Size – Liquid	in (mm)	1/4 (6.35)	1/4 (6.35)	1/4 (6.35)	3/8 (9.52)
Pipe Connection Size – Suction	in (mm)	1/2 (12.7)	1/2 (12.7)	1/2 (12.7)	5/8 (16)
Indoor					
Unit Width	in (mm)	32.00 (813)	32.00 (813)	38.36 (974)	43.83 (1,113)
Unit Height	in (mm)	11.81 (300)	11.81 (300)	12.8 (325)	13.41 (341)
Unit Depth	in (mm)	7.75 (197)	7.75 (197)	8.87 (225)	9.22 (234)
Net Weight	lb (kg)	17.64 (8)	17.64 (8)	23.15 (10.5)	30.86 (14)
Number of Fan Speeds		4	4	4	4
Airflow (lowest to highest)	cfm	190/239/301/328	188/238/305	344/422/506/550	420/514/609/640
Sound Pressure (lowest to highest)	dB(A)	29/36/41/42	28/35/40/42	34/39/43/45	39/44/49/49
Air Throw Data	ft (m)	22 (6.7)	22 (6.7)	24 (7.3)	39.4 (12)
Moisture Removal	Pint/h (L/h)	3.17 (1.50)	3.09 (1.46)	4.61 (2.18)	6.38 (3.02)
Field Drain Pipe Size O.D.	in (mm)	0.625 (16)	0.625 (16)	0.625 (16)	0.625 (16)

Performance may vary based on the compatible outdoor units. See respective pages for performance data.

**COMFORT SERIES**  
40MHH HIGH WALL

**SPECIFICATIONS:**

40MHH High Wall						
Heat Pump System						
Size		12	9	12	18	24
Indoor Model		40MHHQ12---1	40MHHQ09---3	40MHHQ12---3	40MHHQ18---3	40MHHQ24---3
Electrical						
Voltage, Phase, Cycle	V/Ph/Hz	115-1-60	208/230-1-60	208/230-1-60	208/230-1-60	208/230-1-60
Power Supply		Indoor unit powered from outdoor unit				
MCA	A	0.3	0.25	0.25	0.28	0.45
Controls						
Wireless Remote Controller (°F/°C Convertible)		Standard	Standard	Standard	Standard	Standard
Wired Remote Controller (°F/°C Convertible)		Optional	Optional	Optional	Optional	Optional
Operating Range						
Cooling Indoor DB Min-Max	°F (°C)	63~90 (17~32)	63~90 (17~32)	63~90 (17~32)	63~90 (17~32)	63~90 (17~32)
Heating Indoor DB Min-Max	°F (°C)	32~86 (0~30)	32~86 (0~30)	32~86 (0~30)	32~86 (0~30)	32~86 (0~30)
Piping						
Pipe Connection Size – Liquid	in (mm)	1/4 (6.35)	1/4 (6.35)	1/4 (6.35)	1/4 (6.35)	3/8 (9.52)
Pipe Connection Size – Suction	in (mm)	1/2 (12.7)	3/8 (9.52)	1/2 (12.7)	1/2 (12.7)	5/8 (16)
Indoor						
Unit Width	in (mm)	32.00 (813)	28.53 (725)	32.00 (813)	38.36 (974)	43.83 (1,113)
Unit Height	in (mm)	11.81 (300)	11.81 (300)	11.81 (300)	12.8 (325)	13.41 (341)
Unit Depth	in (mm)	7.75 (197)	7.75 (197)	7.75 (197)	8.87 (225)	9.22 (234)
Net Weight	lb (kg)	22.49 (10.2)	21.16 (9.6)	22.49 (10.2)	31.97 (14.5)	40.12 (18.2)
Number of Fan Speeds		4	4	4	4	4
Airflow (lowest to highest)	cfm	200/265/306/329	165/229/271/324	212/282/324/353	353/412/529/559	353/483/589/647
Sound Pressure (lowest to highest)	dB(A)	29/38/42/42	31/36/40/42	34/39/41/43	34/39/44/46	38/42/48/49
Air Throw Data	ft (m)	22 (6.7)	20.3 (6.2)	22.6 (6.9)	25 (7.6)	37.7 (11.5)
Moisture Removal	Pint/h (L/h)	3.49 (1.65)	2.05 (0.97)	3.38 (1.6)	4.63 (2.19)	5.73 (2.71)
Field Drain Pipe Size O.D.	in (mm)	0.625 (16)	0.625 (16)	0.625 (16)	0.625 (16)	0.625 (16)

Performance may vary based on the compatible outdoor units. See respective pages for performance data.



**COMFORT SERIES**  
40MHH HIGH WALL

**COMPATIBILITY:**

<b>Cooling Only</b>				
Indoor Unit	40MHHC12---1	40MHHC12---3	40MHHC18---3	40MHHC24---3
Outdoor Unit Single Zone	38MHRBC12AA1	38MHRBC12AA3	38MHRBC18AA3	38MHRBC24AA3
Outdoor Unit Multi-zone				

Backward compatible with 38MHRC Single Zone

**COMPATIBILITY:**

<b>Heat Pump</b>					
Indoor Unit	40MHHQ12---1	40MHHQ09---3	40MHHQ12---3	40MHHQ18---3	40MHHQ24---3
Outdoor Unit Single Zone	38MHRBQ12AA1	38MHRBQ09AA3	38MHRBQ12AA3	38MHRBQ18AA3	38MHRBQ24AA3
Outdoor Unit Multi-zone		38MGRQ18B--3			
		38MGRQ24C--3			
		38MGRQ30D--3			
		38MGRQ36D--3			
		38MGRQ48E--3			

Backward compatible with 38MHRQ Single Zone



# Multi-zone

**INFINITY SERIES**  
38VMH OUTDOOR UNIT



36, 48 and 60K

# Infinity® Series VRF Heat Pump

**FEATURES**

- Up to 18.6 SEER cooling efficiency
- Up to 10.0 HSPF heating efficiency
- Available in 3-, 4- and 5-ton capacity range
- 208/230-1-60Hz power supply
- Ability to connect up to nine multiple-style indoor units on a 5-ton system
- Heat pump system
- High-performance outdoor unit with Inverter-driven scroll compressor
- Cooling operating range 5°~118°F
- Heating operating range -13°~64°F
- Connected capacity up to 130%
- Quiet outdoor operation, as low as 58.7 dB(A)

**COMPATIBLE WITH:**

The 38VMH heat pump system can be matched with the following indoor units and controls:

40VMA, 40VMC, 40VMF, 40VMH, 40VML, 40VMM, 40VMR, 40VMU, 40VMV, 40VMW & 40VM9 (controller)

**CARRIER® VRF**

Heat Pump System  
36,000 to 60,000 Btu/h  
3 to 5 tons

**KEY FEATURES:**

The Carrier 38VMH VRF heat pump system is a combination of an outdoor unit with multiple-style indoor units connected by refrigerant piping and wiring. The outdoor units have stacked dual-condenser fan with side-blow arrangement.



**4-way Compact Cassette 40VMC**



**4-way Cassette 40VMF**



**Low Static Duct 40VML**



**Medium Static Duct 40VMM**



**Floor Console 40VMR**



**Underceiling 40VMU**



**Verticle AHU 40VMV**



**High Wall 40VMW**





# INFINITY SERIES 38VMH OUTDOOR UNIT

## SPECIFICATIONS:

38VMH Outdoor Unit						
System						
Outdoor Unit Model Name			38VMA036HDS3-1	38VMA048HDS3-1	38VMA060HDS3-1	
Nominal Tons		Ton	3	4	5	
Performance						
Cooling Capacity (*1) (with non-ducted indoor units/ducted)	Nominal	kBtu/h	36,000	48,000	60,000	
	Rated	kBtu/h	36,000	48,000	60,000	
Heating Capacity (*1) (with non-ducted indoor units/ducted)	Nominal	kBtu/h	40,000	52,500	66,000	
	Rated	kBtu/h	40,000	52,500	66,000	
Performance Non-Ducted						
With Non-ducted Indoor Units	Power Supply (*2)		208/230V, 1-Phase, 60Hz			
	Cooling	Power Consumption	kW	3.1	4.6	6.1
		SEER (Seasonal Energy Efficiency Ratio)	Btu/W	18.0	18.0	18.6
	Heating	Power Consumption	kW	3.1	4.3	5.8
		HSPF (Heating Seasonal Performance Factor)	Btu/W	9.2	9.2	9.6
	Electrical Characteristics (Nominal) (*1)					
Performance Ducted						
With Ducted Indoor Units	Power Supply (*2)		208/230V, 1-Phase, 60Hz			
	Cooling	Power Consumption	kW	2.9	4.7	6.1
		SEER (Seasonal Energy Efficiency Ratio)	Btu/W	17.8	17.8	18.6
	Heating	Power Consumption	kW	3.0	4.2	5.7
		HSPF (Heating Seasonal Performance Factor)	Btu/W	9.6	9.6	10.0
	Electrical Characteristics (Nominal) (*1)					
Dimensions						
Height		in	52-1/4			
Width		in	35-1/2			
Depth		in	15-3/4			
Total Weight	Unit	lb	220			
Compressor						
Type/Quantity		Inverter-Driven Hermetic Rotary/1				
Motor Output		kW	13			
Fan Unit						
Motor Output		W	90+90			
Air Volume		cfm	4,100			
Refrigerant (*3) (charged refrigerant amount)		lb	8.6			
Electrical Specifications	Unit	MCA (*4)	A	36	38	40
		Recommended Fuse Size	A	40	40	45
Piping						
Refrigerant Piping	Connecting Port Diameter	Gas Side (main pipe) (brazing)	in	5/8	3/4	
		Liquid Side (main pipe) (brazing)	in	3/8		
Operation Temperature Range						
Cooling		°F DB	5~118			
Heating		°F WB	-13~64			
Indoor						
Maximum Number of Connected Indoor Units			5	7	9	
Maximum Capacity of Combined Indoor Units			50 to 130%			
Sound Pressure Level Cooling/Heating (*5)		dB(A)	58.7	60.1	60.7	

Specifications subject to change.

(\*1) Rated conditions.

Cooling: Indoor air temperature 80 °F dry bulb/67 °F wet bulb, outdoor air temperature 95 °F dry bulb.

Heating: Indoor air temperature 70 °F dry bulb, outdoor air temperature 47 °F dry bulb/43 °F wet bulb.

(\*2) The source voltage must not fluctuate more than +/-10%.

(\*3) The amount does not consider extra piping length. Refrigerant must be added on site in accordance with the actual piping length.

(\*4) Select wire size based on larger value of MCA.

MCA: Minimum Circuit Amps (Minimum Circuit Amps required for power supply design).

(\*5) These values, measured in anechoic chamber, at a point 1m in front of the unit at a height of 1.4m. During actual operation, these values are normally somewhat higher as a result of ambient conditions.

**TOSHIBA CARRIER SERIES**  
MMYF HEAT RECOVERY OUTDOOR UNIT



# Toshiba Carrier VRF Heat Recovery

## FEATURES

- Available in 6-ton single module which can be twinned up to 12-ton capacity
- Ability to connect up to 25 indoor units
- 3-pipe heat recovery system
- High-performance outdoor units with all Inverter-driven twin rotary compressor
- DC inverter condenser fan motor
- 208/230-1-60Hz voltage
- Cooling ambient operating temperature is 14°~122°F
- Heating ambient operating temperature is -13°~60°F
- Connected capacity up to 150%

## COMPATIBLE WITH:

The MMYF-SP heat recovery unit is matched with multiple VRF fan coils.

## TOSHIBA CARRIER VRF

Heat Recovery System

72,000 or 144,000 Btu/h

6 or 12 tons

The Toshiba Carrier VRF system is a combination of an outdoor unit with multiple-style indoor units connected by refrigerant piping and wiring. The VRF heat recovery outdoor unit is a single module with twinning capability up to 12 tons to achieve greater capacity.

**TOSHIBA**  
*Carrier*

**TOSHIBA CARRIER SERIES**  
MMYF HEAT RECOVERY OUTDOOR UNIT

**SPECIFICATIONS:**

MMYF Outdoor Unit					
System					
Outdoor Unit Set Model Name	MMY-		MAP0726FT2P-UL	AP1446FT2P-UL	
Outdoor Unit Model Name	MMY-MAP			0726FT2P-UL	
Nominal Tons		Ton	6	12	
Performance					
Cooling Capacity (*1) (with non-ducted indoor units/ducted)	Nominal		kBtu/h	72	144
	Rated		kBtu/h	69	138
Heating Capacity (*1) (with non-ducted indoor units/ducted)	Nominal		kBtu/h	81	162
	Rated		kBtu/h	77	154
Performance Non-Ducted					
With Non-ducted Indoor Units	Power Supply (*2)		208/230V, 1-Phase, 60Hz		
	Cooling	Power Consumption (*6)	kW	4.43	9.65
		IEER (Integrated Energy Efficiency Ratio)	Btu/W	27.4	26.4
	Heating	Power Consumption (*6)	kW	5.98	11.69
		SCHE (Simultaneous Cooling & Heating Efficiency)	Btu/W	30.6	31.3
Performance Ducted					
With Ducted Indoor Units	Power Supply (*2)		208/230V, 1-Phase, 60Hz		
	Cooling	Power Consumption (*6)	kW	4.88	9.81
		IEER (Integrated Energy Efficiency Ratio)	Btu/W	20.6	22.6
	Heating	Power Consumption (*6)	kW	6.10	11.56
		SCHE (Simultaneous Cooling & Heating Efficiency)	Btu/W	27.8	28.0
Dimensions					
Height			in	72.9	72.9
Width			in	39.0	39.0 x 2
Depth			in	30.7	30.7
Total Weight	Unit		lb	600	600 + 600
Compressor					
Type	Hermetic Twin Rotary Compressor				
Fan Unit					
Air Volume			cfm	5,900	5,900 x 2
Maximum External Static Pressure			in WG	0.24	0.24
Refrigerant (*3) (charged refrigerant amount)			lb	24.3	24.3 x 2
Electrical Specifications	Unit	MCA (*4)	A	47	47 + 47
		Recommended Fuse Size	A	50	50 + 50
Piping					
Refrigerant Piping	Connecting Port Diameter	Gas Side (main pipe) (brazing)	in	7/8	1-1/8
		Liquid Side (main pipe) (flare)	in	1/2	5/8
		Discharge (main pipe) (flare)	in	3/4	7/8
		Balance Pipe (flare)	in	3/8	3/8
Operation Temperature Range					
Cooling			°F DB	14~122	
Heating			°F WB	-13~60	
Indoor					
Maximum Number of Connected Indoor Units				12	25
Maximum Capacity of Combined Indoor Units				50 to 150%	
Sound Pressure Level Cooling/Heating (*5)			dB(A)	57/60	60/63

(\*1) Rated conditions      Cooling: Indoor 80° F Dry Bulb/67° F Wet Bulb, Outdoor 95° F Dry Bulb.  
Heating: Indoor 70° F Dry Bulb, Outdoor 47° F Dry Bulb/43° F Wet Bulb.

The standard pipe      144 type – 228 type      Equivalent piping length: 25 ft, Height difference: 0 ft

(\*2) The source voltage must not fluctuate more than ±10%.

(\*3) The amount does not consider extra piping length. Refrigerant must be added on site in accordance with the actual piping length.

(\*4) Select wire size based on the larger value of MCA.

MCA: Minimum Circuit Amps (Minimum Circuit Amps required for power supply design).

(\*5) In case the diversity exceeds 135%, the type of indoor unit is limited and the maximum number of indoor unit is reduced.

(\*6) Only for outdoor unit.

**TOSHIBA CARRIER SERIES**  
MCY7 HEAT PUMP OUTDOOR UNIT



# Toshiba Carrier VRF Heat Pump

## FEATURES

- Available in 3-, 4- and 5-ton capacity range
- Ability to connect up to nine multiple-style indoor units on a 5-ton system
- Heat pump system
- High-performance outdoor unit with Inverter-driven twin rotary compressor
- 208/230-1-60Hz power supply
- Cooling operating range 23°~122°F
- Heating operating range -13°~60°F
- Connected capacity up to 135%
- Up to 21.5 SEER cooling efficiency
- Up to 11.5 HSPF heating efficiency
- Quiet outdoor operation

## COMPATIBLE WITH:

The MCY7 heat pump is matched with multiple VRF fan coils.

## TOSHIBA CARRIER VRF

Heat Pump System  
36,000 to 60,000 Btu/h  
3 to 5 tons

The Toshiba Carrier VRF System is a combination of an outdoor unit with multiple-style indoor units connected by refrigerant piping and wiring. The outdoor units have stacked dual-condenser fan with side-blow arrangement.

## COMPATIBLE INDOOR UNITS:

The MCY7 heat pump is matched with multiple VRF fan coils.

**TOSHIBA**  
*Carrier*



**TOSHIBA CARRIER SERIES**  
MCY7 HEAT PUMP OUTDOOR UNIT

**SPECIFICATIONS:**

MCY7 Outdoor Unit						
System						
Outdoor Unit Model Name	MCY-		MAP0367HS-UL	MAP0487HS-UL	MAP0607HS-UL	
Nominal Tons		Ton	3	4	5	
Performance						
Cooling Capacity (*1) (with non-ducted indoor units/ducted)		Nominal	kBtu/h	36	48	60
Heating Capacity (*1) (with non-ducted indoor units/ducted)		Nominal	kBtu/h	40	54	66
Performance Non-Ducted						
With Non-ducted Indoor Units	Power Supply (*2)		208/230V, 1-Phase, 60Hz			
	Cooling	Power Consumption	kW	2.29	3.71	5.26
		EER (Energy Efficiency Ratio)	Btu/W	15.7	12.95	11.4
	Heating	Power Consumption	kW	2.79	3.95	5.16
		COP (Coefficient of Performance)	Btu/W	4.2	4.01	3.75
	Electrical Characteristics (Nominal) (*1)	SEER (Seasonal Energy Efficiency Ratio)			22.7	21
	HSPF (Heating Seasonal Performance Ratio)			11.5	11.5	11.5
Performance Ducted						
With Ducted Indoor Units	Power Supply (*2)		208/230V, 1-Phase, 60Hz			
	Cooling	Power Consumption	kW	2.76	4.87	5.76
		EER (Energy Efficiency Ratio)	Btu/W	13.05	9.85	10.42
	Heating	Power Consumption	kW	3.45	5.27	5.34
		COP (Coefficient of Performance)	Btu/W	3.4	3	3.62
	Electrical Characteristics (Nominal) (*1)	SEER (Seasonal Energy Efficiency Ratio)			17.7	16.6
	HSPF (Heating Seasonal Performance Ratio)			10.5	9.5	11
Dimensions						
Height		in	61	61	61	
Width		in	39.8	39.8	39.8	
Depth		in	14.6	14.6	14.6	
Total Weight	Unit	lb	311	311	311	
Compressor						
Type	Hermetic Twin Rotary Compressor					
Motor Output		kW	3.75	3.75	3.75	
Fan Unit						
Air Volume		cfm	4,520	4,690	4,850	
Refrigerant R410A (*3) (charged refrigerant amount)		lb	14.8	14.8	14.8	
Electrical Specifications	Unit	MCA (*4)	A	36.3	36.3	36.3
		Recommended Fuse Size	A	40	40	40
Piping						
Refrigerant Piping	Connecting Port Diameter	Gas Side (main pipe) (brazing)	in	5/8	5/8	3/4
		Liquid Side (main pipe) (brazing)	in	3/8	3/8	3/8
Operation Temperature Range						
Cooling		°F DB	23~122			
Heating		°F WB	-13~60			
Indoor						
Maximum Number of Connected Indoor Units			6	8	9	
Maximum Capacity of Combined Indoor Units			80 to 135%	50 to 135%		
Sound Pressure Level Cooling/Heating (*5)		dB(A)	52/56	54/57	55/58	

(\*1) Rated conditions                      Cooling: Indoor 80° F Dry Bulb/67° F Wet Bulb, Outdoor 95° F Dry Bulb.  
Heating: Indoor 70° F Dry Bulb, Outdoor 47° F Dry Bulb/43° F Wet Bulb.

(\*2) The source voltage must not fluctuate more than ±10%.

(\*3) The amount does not consider extra piping length. Refrigerant must be added on site in accordance with the actual piping length.

(\*4) Select wire size based on the larger value of MCA.

MCA: Minimum Circuit Amps (Minimum Circuit Amps required for power supply design).

**PERFORMANCE SERIES**  
38MGR OUTDOOR UNIT



# Performance™ Multi-zone Heat Pump With Basepan Heater

## FEATURES

- 100% heating capacity at 5°F (-15°C)  
– Sizes 24–36 (208/230V)
- Connect 2~5, multiple-style indoor units
- Basepan heater factory installed
- Quiet outdoor operation, as low 62 dB(A)
- Aluminum golden hydrophilic pre-coated fins
- Total piping length 131~328 ft (40~100 m)
- Vertical lift/drop piping length 49~65 ft (15~20 m)
- Cooling operating range -13°~122°F (-25°~50°C)
- Heating operating range -22°~86°F (-30°~30°C)

## COMPATIBLE WITH:

- 40MPHA High Wall (p 20)
- 40MAQ High Wall (p 26)
- 40MHHQ High Wall (p 40)
- 40MBCQ Cassette (p 28)
- 40MBDQ Ducted (p 30)
- 40MBFQ Floor Console (p 32)

Performance  
**SERIES**

## Heat Pump With Basepan Heater

Inverter Compressor

Up to 23.8 SEER

Up to 10.5 HSPF

Sizes: 18/24/30/36/48

## KEY FEATURES

### Space-saving Installation

Up to five indoor units can be connected to a single outdoor unit, reducing the number of outdoor units. All indoor units can be individually controlled and do not need to be installed at the same time.

### Multiple-style Indoor Units

Flexibility on the options of indoor unit styles to fit any application or need.



## COMBINATIONS:

To access the Combination Charts, please see instructions on page 53.

PERFORMANCE SERIES  
38MGR OUTDOOR UNIT

SPECIFICATIONS:

38MGR Outdoor Unit						
Heat Pump						
System						
Size		18	24	30	36	48
Outdoor Model		38MGRQ18B--3	38MGRQ24C--3	38MGRQ30D--3	38MGRQ36D--3	38MGRQ48E--3
Max Number of Zones		2	3	4	4	5
Performance Non-Ducted						
ENERGY STAR®		YES	YES	YES	YES	YES
Cooling System Tons		1.5	2.0	2.5	3.0	4.0
Cooling Rated Capacity	Btu/h	18,000	24,000	30,000	36,000	48,000
Cooling Cap. Range Min–Max	Btu/h	5,810–21,940	7,880–33,510	8,090–41,470	8,560–45,020	8,560–53,160
SEER		22.5	23	23.8	21.5	22.4
EER		12.5	12.5	12.5	13.5	12.5
Heating Rated Capacity (47°F)	Btu/h	19,000	23,000	28,000	36,000	48,000
Heating Maximum Capacity (5°F)	Btu/h	13,900	23,000	28,000	36,000	36,000
Heating Maximum Capacity (–13°F)	Btu/h	6,540	17,590	20,650	27,690	28,050
Heating Cap. Range Min–Max	Btu/h	5,760–24,480	6,010–36,180	6,350–41,950	7,210–50,350	7,210–55,820
HSPF		10.3	10.0	10.0	10.5	10.2
COP (47°F)	W/W	3.6	3.9	3.8	3.8	3.6
COP (5°F)	W/W	2.2	2.1	2.0	1.8	2.0
Performance Combination Ducted and Non-Ducted						
ENERGY STAR®		NO	YES	NO	NO	NO
Cooling System Tons		1.5	1.9	2.4	3.0	4.0
Cooling Rated Capacity	Btu/h	18,000	23,000	29,000	35,500	48,000
Cooling Cap. Range Min–Max	Btu/h	5,795–20,708	7,765–31,955	8,060–39,990	8,510–42,635	8,510–52,580
SEER		20.45	21	21.65	19.25	20
EER		12.15	12.5	12	12.15	11.3
Heating Rated Capacity (47°F)	Btu/h	18,750	22,000	28,000	36,000	49,000
Heating Maximum Capacity (5°F)	Btu/h	14,150	22,000	28,000	35,500	36,400
Heating Maximum Capacity (–13°F)	Btu/h	6,350	17,480	20,520	27,245	27,600
Heating Cap. Range Min–Max	Btu/h	5,650–24,365	5,980–36,190	6,275–42,305	7,045–47,800	7,045–54,935
HSPF		9.9	9.4	9.5	9.9	10.2
COP (47°F)	W/W	3.7	3.9	3.7	3.7	3.5
COP (5°F)	W/W	2.1	2.0	2.0	1.8	1.9
Performance Ducted						
ENERGY STAR®		NO	YES	NO	NO	NO
Cooling System Tons		1.5	1.8	2.3	2.9	4.0
Cooling Rated Capacity	Btu/h	18,000	22,000	28,000	35,000	48,000
Cooling Cap. Range Min–Max	Btu/h	5,780–19,476	7,650–30,400	8,030–38,510	8,460–40,250	8,460–52,000
SEER		18.4	19	19.5	17	17.6
EER		11.8	12.5	11.5	10.8	10.1
Heating Rated Capacity (47°F)	Btu/h	18,500	21,000	28,000	36,000	50,000
Heating Maximum Capacity (5°F)	Btu/h	14,400	21,000	28,000	35,000	36,800
Heating Maximum Capacity (–13°F)	Btu/h	6,160	17,370	20,390	26,800	27,150
Heating Cap. Range Min–Max	Btu/h	5,539–24,249	5,950–36,200	6,200–42,660	6,880–45,250	6,880–54,050
HSPF		9.4	8.8	9.0	9.2	10.1
COP (47°F)	W/W	3.8	3.8	3.6	3.6	3.4
COP (5°F)	W/W	2.1	2.0	2.0	1.7	1.8
Operating Range						
Cooling Outdoor DB Min–Max	°F (°C)	–13–122 (–25–50)	–13–122 (–25–50)	–13–122 (–25–50)	–13–122 (–25–50)	–13–122 (–25–50)
Heating Outdoor DB Min–Max	°F (°C)	–22–86 (–30–30)	–22–86 (–30–30)	–22–86 (–30–30)	–22–86 (–30–30)	–22–86 (–30–30)
Piping						
Total Piping Length	ft (m)	131 (40)	197 (60)	263 (80)	328 (100)	328 (100)
Piping to furthest FCU	ft (m)	82 (25)	98 (30)	115 (35)	115 (35)	115 (35)
Drop (OD above ID)	ft (m)	49 (15)	49 (15)	49 (15)	65 (20)	65 (20)
Lift (OD below ID)	ft (m)	49 (15)	49 (15)	49 (15)	65 (20)	65 (20)
Pipe Connection Size – Liquid	in (mm)	1/4*2 (6.35*2)	1/4*3 (6.35*3)	1/4*4 (6.35*4)	1/4*4 (6.35*4)	1/4*5 (6.35*5)
Pipe Connection Size – Suction	in (mm)	3/8*2 (9.52*2)	3/8*3 (9.52*3)	1/2 *1+ 3/8*3 (12.7*1+9.52*3)	1/2 *2+ 3/8*2 (12.7*2+9.52*2)	1/2 *2+ 3/8*3 (12.7*2+9.52*3)

# PERFORMANCE SERIES 38MGR OUTDOOR UNIT

## SPECIFICATIONS:

38MGR Outdoor Unit											
Heat Pump											
System											
Size	18		24		30		36		48		
Outdoor Model	38MGRQ18B--3		38MGRQ24C--3		38MGRQ30D--3		38MGRQ36D--3		38MGRQ48E--3		
Refrigerant											
Type	R410A		R410A		R410A		R410A		R410A		
Charge	lb (kg)	4.41 (2.0)		6.17(2.8)		6.61 (3.0)		10.13 (4.6)		10.13 (4.6)	
Electrical											
Voltage, Phase, Cycle	V/Ph/Hz	208/230-1-60		208/230-1-60		208/230-1-60		208/230-1-60		208/230-1-60	
Power Supply	Indoor unit powered from outdoor unit										
MCA	A	18		25		30		35		35	
MOCP – Fuse Rating	A	25		35		45		50		50	
Compressor											
Type	Rotary Inverter		Rotary Inverter		Rotary Inverter		Rotary Inverter		Rotary Inverter		
Outdoor											
Unit Width	in (mm)	37.31 (948)		41.22 (1,047)		41.22 (1,047)		41.15 (1,045)		41.15 (1,045)	
Unit Height	in (mm)	27.64 (702)		31.88 (810)		31.88 (810)		52.48 (1,333)		52.48 (1,333)	
Unit Depth	in (mm)	14.82 (376)		17.91 (455)		17.91 (455)		17.63 (448)		17.63 (448)	
Net Weight	lb (kg)	105.8 (48)		149.9 (68)		156.5 (71)		221.6 (100.5)		223.8 (101.5)	
Airflow	cfm	1,390		2,130		2,130		4,500		4,500	
Sound Pressure	dB(A)	62		63		62		64		64	

## COMPATIBILITY:

Indoor Unit		Outdoor Unit				
		38MGRQ18B--3	38MGRQ24C--3	38MGRQ30D--3	38MGRQ36D--3	38MGRQ48E--3
High Wall	40MPHAQ09XA3	•	•	•	•	•
	40MPHAQ12XA3	•	•	•	•	•
High Wall	40MAQB09B--3	•	•	•	•	•
	40MAQB12B--3	•	•	•	•	•
	40MAQB18B--3		•	•	•	•
	40MAQB24B--3			•	•	•
High Wall	40MHHQ09---3	•	•	•	•	•
	40MHHQ12---3	•	•	•	•	•
	40MHHQ18---3		•	•	•	•
	40MHHQ24---3			•	•	•
Cassette	40MBCQ09---3	•	•	•	•	•
	40MBCQ12---3	•	•	•	•	•
	40MBCQ18---3		•	•	•	•
	40MBCQ24---3			•	•	•
Ducted	40MBDQ09---3	•	•	•	•	•
	40MBDQ12---3	•	•	•	•	•
	40MBDQ18---3		•	•	•	•
	40MBDQ24---3			•	•	•
Console	40MBFQ12---3	•	•	•	•	•
	40MBFQ18---3		•	•	•	•
	40MBFQ24---3			•	•	•



**PERFORMANCE SERIES**  
**38MGR OUTDOOR UNIT**

**COMBINATION CHART:**

38MGR Outdoor Unit				
Heat Pump				
Outdoor Unit Model	2-Zone	3-Zone	4-Zone	5-Zone
38MGRQ18B--3	9+9			
	9+12			
	12+12			
38MGRQ24C--3	9+9	9+9+9		
	9+12	9+9+12		
	9+18	9+9+18		
	12+12	9+12+12		
	12+18	12+12+12		
	18+18			
38MGRQ30D--3	9+9	9+9+9	9+9+9+9	
	9+12	9+9+12	9+9+9+12	
	9+18	9+9+18	9+9+9+18	
	9+24	9+9+24	9+9+12+12	
	12+12	9+12+12	9+9+12+18	
	12+18	9+12+18	9+12+12+12	
	12+24	9+18+18	12+12+12+12	
	18+18	12+12+12		
		12+12+18		
		12+18+18		
	12+12+24			
38MGRQ36D--3	9+18	9+9+9	9+9+9+9	
	9+24	9+9+12	9+9+9+12	
	12+12	9+9+18	9+9+9+18	
	12+18	9+9+24	9+9+9+24	
	12+24	9+12+12	9+9+12+12	
	18+18	9+12+18	9+9+12+18	
	18+24	9+12+24	9+9+12+24	
	24+24	9+18+18	9+9+18+18	
		9+18+24	9+9+18+24	
		9+24+24	9+12+12+12	
		12+12+12	9+12+12+18	
		12+12+18	9+12+12+24	
		12+12+24	9+12+18+18	
		12+18+18	9+18+18+18	
		12+18+24	12+12+12+12	
		12+24+24	12+12+12+18	
	18+18+18	12+12+12+24		
	18+18+24	12+12+18+18		
38MGRQ48E--3	9+18	9+9+9	9+9+9+9	9+9+9+9+9
	9+24	9+9+12	9+9+9+12	9+9+9+9+12
	12+12	9+9+18	9+9+9+18	9+9+9+9+18
	12+18	9+9+24	9+9+9+24	9+9+9+9+24
	12+24	9+12+12	9+9+12+12	9+9+9+12+12
	18+18	9+12+18	9+9+12+18	9+9+9+12+18
	18+24	9+12+24	9+9+12+24	9+9+9+18+18
	24+24	9+18+18	9+9+18+18	9+9+12+12+12
		9+18+24	9+9+18+24	9+9+12+12+18
		9+24+24	9+12+12+12	9+12+12+12+12
		12+12+12	9+12+12+18	9+12+12+12+18
		12+12+18	9+12+12+24	12+12+12+12+12
		12+12+24	9+12+18+18	
		12+18+18	9+18+18+18	
		12+18+24	12+12+12+12	
		12+24+24	12+12+12+18	
	18+18+18	12+12+12+24		
	18+18+24	12+12+18+18		



# Light Commercial

**PERFORMANCE SERIES**  
38MBR OUTDOOR UNIT



36K

48K and 58K

# Performance™ Commercial Heat Pump

## FEATURES OUTDOOR

- Inverter Compressor
- Built-in basepan heater
- Condenser high-temperature protection
- Refrigerant leakage detection
- Quiet outdoor operation, as low as 62.5 dB(A)
- Aluminum golden hydrophilic pre-coated fins
- Piping length 213 ft (65 m)
- Cooling operating range -13°~122°F (-25°~50°C)
- Heating operating range -22°~86°F (-30°~30°C)

## COMPATIBLE WITH:

- 40MBCQ Cassette (p 60)
- 40MBDQ Ducted (p 62)
- 40MBFQ Console (p 64)

## Heat Pump With Basepan Heater

Inverter Compressor  
Up to 17.4 SEER  
Up to 10.5 HSPF  
Sizes: 36/48/58

## KEY FEATURES

### Longer Piping Lengths

Piping flexibility up to a total piping length of 213 ft (65m)

### Low Ambient Cooling

With built-in low ambient kit or special designed PCB, outdoor fan speeds can be changed automatically based on the temperature. The unit can run cooling operation even in low ambient temperatures.



Cassette



Ducted



Console

Performance™  
**SERIES**



**PERFORMANCE SERIES**  
38MBR OUTDOOR UNIT

**SPECIFICATIONS:**

38MBR Outdoor Unit				
Heat Pump				
System				
Size		36	48	58
Outdoor Model		38MBRQ36A--3	38MBRQ48A--3	38MBRQ58A--3
Electrical				
Voltage, Phase, Cycle	V/Ph/Hz	208/230-1-60	208/230-1-60	208/230-1-60
MCA	A	30	35	35
MOCP – Fuse Rating	A	50	50	50
Operating Range				
Cooling Outdoor DB Min–Max	°F (°C)	-13~122 (-25~50)	-13~122 (-25~50)	-13~122 (-25~50)
Heating Outdoor DB Min–Max	°F (°C)	-22~86 (-30~30)	-22~86 (-30~30)	-22~86 (-30~30)
Piping				
Total Piping Length	ft (m)	213 (65)	213 (65)	213 (65)
Piping Lift*	ft (m)	98 (30)	98 (30)	98 (30)
Pipe Connection Size – Liquid	in (mm)	3/8 (9.52)	3/8 (9.52)	3/8 (9.52)
Pipe Connection Size – Suction	in (mm)	5/8 (16)	5/8 (16)	3/4 (19)
Refrigerant				
Type		R410A	R410A	R410A
Charge	lb (kg)	6.72 (3.05)	9.26 (4.2)	10.19 (4.62)
Compressor				
Type		Rotary Inverter	Rotary Inverter	Rotary Inverter
Outdoor				
Unit Width	in (mm)	37.24 (946)	37.48 (952)	37.48 (952)
Unit Height	in (mm)	31.89 (810)	52.48 (1,333)	52.48 (1,333)
Unit Depth	in (mm)	16.14 (410)	16.34 (415)	16.34 (415)
Net Weight	lb (kg)	136.47 (61.9)	217.4 (98.6)	225.09 (102.1)
Airflow	cfm	2,130	4,500	4,415
Sound Pressure	dB(A)	63.0	62.5	64.0

\*Condensing unit above or below indoor unit.

**COMPATIBILITY:**

Indoor Unit		Outdoor Unit		
		38MBRQ36A--3	38MBRQ48A--3	38MBRQ58A--3
Cassette	40MBCQ36---3	•		
	40MBCQ48---3		•	
Ducted	40MBDQ36---3	•		
	40MBDQ48---3		•	
	40MBDQ58---3			•
Console	40MBFQ36---3	•		
	40MBFQ48---3		•	
	40MBFQ58---3			•

**PERFORMANCE SERIES**  
38MBR OUTDOOR UNIT

**PERFORMANCE:**

<b>40MBCQ Cassette</b>			
Indoor Model		40MBCQ36---3	40MBCQ48---3
<b>ENERGY STAR®</b>		<b>NO</b>	<b>NO</b>
Cooling System Tons		3.0	4.0
Cooling Rated Capacity	Btu/h	36,000	48,000
Cooling Cap. Range Min–Max	Btu/h	8,500~38,000	9,000~50,000
SEER		17.5	16.8
EER		9	9.5
Heating Rated Capacity (47°F)	Btu/h	38,000	50,000
Heating Rated Capacity (17°F)	Btu/h	25,200	35,000
Heating Capacity (5°F)	Btu/h	25,300	34,000
Heating Cap. Range Min–Max	Btu/h	9,500~50,000	10,000~55,000
HSPF		10.5	11.0
COP (47°F)	W/W	3	3.6
COP (17°F)	W/W	2.46	2.62
COP (5°F)	W/W	1.71	1.84

**PERFORMANCE:**

<b>40MBDQ Ducted</b>				
Indoor Model		40MBDQ36---3	40MBDQ48---3	40MBDQ58---3
<b>ENERGY STAR®</b>		<b>NO</b>	<b>NO</b>	<b>NO</b>
Cooling System Tons		3.0	4.0	4.8
Cooling Rated Capacity	Btu/h	36,000	48,000	57,000
Cooling Cap. Range Min–Max	Btu/h	8,500~38,000	9,000~50,000	18,000~58,000
SEER		16.5	17.4	18
EER		9	9.2	10
Heating Rated Capacity (47°F)	Btu/h	40,000	49,500	62,000
Heating Rated Capacity (17°F)	Btu/h	27,600	33,400	37,600
Heating Capacity (5°F)	Btu/h	25,300	34,000	35,000
Heating Cap. Range Min–Max	Btu/h	9,500~50,000	10,000~55,000	12,000~63,000
HSPF		11.5	10.3	9.0
COP (47°F)	W/W	3	3.6	3.6
COP (17°F)	W/W	2.46	2.62	2.62
COP (5°F)	W/W	1.71	1.84	1.91

**PERFORMANCE SERIES**  
**38MBR OUTDOOR UNIT**

**PERFORMANCE:**

<b>40MBFQ Console</b>				
Indoor Model		40MBFQ36---3	40MBFQ48---3	40MBFQ58---3
<b>ENERGY STAR®</b>		<b>NO</b>	<b>NO</b>	<b>NO</b>
Cooling System Tons		3.0	4.0	4.5
Cooling Rated Capacity	Btu/h	36,000	48,000	54,000
Cooling Cap. Range Min–Max	Btu/h	8,500~38,000	9,000~50,000	18,000~58,000
SEER		16	17.8	18
EER		8	9.3	9.8
Heating Rated Capacity (47°F)	Btu/h	38,000	50,000	60,000
Heating Rated Capacity (17°F)	Btu/h	25,400	35,000	39,000
Heating Capacity (5°F)	Btu/h	25,300	34,000	35,000
Heating Cap. Range Min–Max	Btu/h	9,500~50,000	10,000~55,000	12,000~63,000
HSPF		10.0	11.0	10.5
COP (47°F)	W/W	3	3.6	3.6
COP (17°F)	W/W	2.46	2.62	2.62
COP (5°F)	W/W	1.71	1.84	1.91

**PERFORMANCE SERIES**  
40MBCQ CASSETTE



# Performance™ Cassette Indoor Unit

## FEATURES OUTDOOR

- Modes: Cool, Heat, Dry, Fan, Auto
- Auto-restart function
- Louver control (fixed or swing)
- Three fan speeds
- Outside air intake
- Built-in condensate lift pump
- *Follow Me* (senses temperature at handheld remote)
- Heating Setback (46°F Heating Mode)
- Quiet indoor operation, as low as 49 dB(A)
- Aluminum golden hydrophilic pre-coated fins
- Grille/ceiling panel 3" x 3" P/N 40MBCQ02XXX3

## COMPATIBLE WITH:

- 38MBR Outdoor Unit Single Zone (p 56)

Performance™  
SERIES

Sizes: 36/48

## KEY FEATURES

### Built-in Condensate Lift Pump

The cassette is supplied with a condensate lift pump that is capable of lifting the water 29.5in (750mm) above the top of the unit.

### 360° Airflow Panel

With the 360° Airflow panel, air is distributed to every corner of the room.

## CONTROLS

Wireless Remote Controller included with indoor unit



Optional Wired Remote Controller KSACN0101AAA (Timer Function)

Optional Wired Remote Controller KSACN0501AAA (7-Day Programmable)

## ACCESSORIES

Wi-Fi® Kit

24V Interface for third-party thermostat compatibility

Grille is required; sold separately.



**Optional  
Wired Controller  
(7-Day Programmable)  
KSACN0501AAA**



**Wireless  
Remote  
Controller**

**PERFORMANCE SERIES**  
40MBCQ CASSETTE

**SPECIFICATIONS:**

40MBCQ Cassette			
Heat Pump System			
Size		36	48
Indoor Model		40MBCQ36---3	40MBCQ48---3
Electrical			
Voltage, Phase, Cycle		V/Ph/Hz	208/230-1-60
Power Supply		Indoor unit powered from outdoor unit	
MCA		A	0.8
			1.6
Controls			
Wireless Remote Controller (°F/°C Convertible)		Standard	Standard
Wired Remote Controller (°F/°C Convertible)		Optional	Optional
Operating Range			
Cooling Indoor DB Min–Max		°F (°C)	63~90 (17~32)
Heating Indoor DB Min–Max		°F (°C)	32~86 (0~30)
			63~90 (17~32)
			32~86 (0~30)
Piping			
Pipe Connection Size – Liquid		in (mm)	3/8 (9.52)
Pipe Connection Size – Suction		in (mm)	5/8 (16)
			3/8 (9.52)
			5/8 (16)
Indoor			
Body Unit Width		in (mm)	33.07 (840)
Body Unit Height		in (mm)	9.65 (245)
Body Unit Depth		in (mm)	11.3 (287)
Body Net Weight		lb (kg)	33.07 (840)
Panel Unit Width		in (mm)	58.2 (26.4)
Panel Unit Height		in (mm)	37.4 (950)
Panel Unit Depth		in (mm)	2.17 (55)
Panel Net Weight		lb (kg)	37.4 (950)
Number of Fan Speeds			11.02 (5)
Airflow (lowest to highest)		cfm	3
Sound Pressure (lowest to highest)		dB(A)	809/958/1,095
Air Throw Data		ft (m)	853/1,030/1,177
Moisture Removal		Pint/h (L/h)	49/52/55
Field Drain Pipe Size O.D.		in (mm)	30 (9)
			8.53 (4.04)
			13.5 (6.39)
			1 (25.4)

Performance may vary based on the compatible outdoor units. See respective pages for performance data.

**COMPATIBILITY:**

Indoor Unit	40MBCQ36---3	40MBCQ48---3
Outdoor Unit Single Zone	38MBRQ36A--3	38MBRQ48A--3



**PERFORMANCE SERIES**  
40MBDQ DUCTED

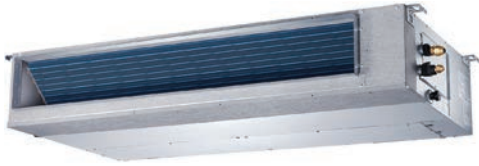

36K & 48K



58K

# Performance™ Ducted Indoor Unit

## FEATURES OUTDOOR

- Modes: Cool, Heat, Dry, Fan, Auto
- Vertical (sizes 36 & 48) or horizontal installation
- Up to 0.8 in WG
- Rear or bottom return
- Outside air intake
- Built-in condensate lift pump
- *Follow Me* (senses temperature at handheld remote)
- Heating Setback (46°F Heating Mode)
- Quiet indoor operation, as low as 38.5 dB(A)
- Aluminum golden hydrophilic pre-coated fins

## COMPATIBLE WITH:

- 38MBR Outdoor Unit (p 56)  
Single Zone

Sizes: 36/48/58

## KEY FEATURES

### Vertical or Horizontal Installation

Designed for maximum installation flexibility. The secondary drain built-in allows the unit to be mounted vertically allowing either a floor or ceiling-concealed installation depending on existing conditions. (Sizes 36 and 48 only.)

### Built-in Condensate Lift Pump

Supplied with a condensate lift pump that is capable of lifting the water 29.5in (750mm) above the top of the unit.

## CONTROLS

Wireless Remote Controller included with indoor unit



Wired Remote Controller (7-Day Programmable) included with indoor unit

## ACCESSORIES

Wi-Fi® Kit

24V Interface for third-party thermostat compatibility

Performance™  
SERIES



**Standard  
Wired Controller  
(7-Day Programmable)  
KSACN0501AAA**



**Wireless  
Remote  
Controller**

**SPECIFICATIONS:**

40MBDQ Ducted				
Heat Pump System				
Size		36	48	58
Indoor Model		40MBDQ36---3	40MBDQ48---3	40MBDQ58---3
Electrical				
Voltage, Phase, Cycle	V/Ph/Hz	208/230-1-60	208/230-1-60	208/230-1-60
Power Supply		Indoor unit powered from outdoor unit		
MCA	A	2.45	3.2	3.65
Controls				
Wireless Remote Controller (°F/°C Convertible)		Standard	Standard	Standard
Wired Remote Controller (°F/°C Convertible)		Standard	Standard	Standard
Operating Range				
Cooling Indoor DB Min–Max	°F (°C)	63~90 (17~32)	63~90 (17~32)	63~90 (17~32)
Heating Indoor DB Min–Max	°F (°C)	32~86 (0~30)	32~86 (0~30)	32~86 (0~30)
Piping				
Pipe Connection Size – Liquid	in (mm)	3/8 (9.52)	3/8 (9.52)	3/8 (9.52)
Pipe Connection Size – Suction	in (mm)	5/8 (16)	5/8 (16)	3/4 (19)
Indoor				
Unit Width	in (mm)	53.54 (1,360)	47.24 (1,200)	55.12 (1,400)
Unit Height	in (mm)	9.8 (249)	11.81 (300)	17.32 (440)
Unit Depth	in (mm)	30.47 (774)	34.41 (874)	33.78 (858)
Net Weight	lb (kg)	106.48 (48.3)	119.71 (54.3)	163 (74)
Number of Fan Speeds		3	3	3
Airflow (lowest to highest)	cfm	700/910/1,080	720/1,030/1,230	1,260/1,710/2,150
Sound Pressure (lowest to highest)	dB(A)	38.5/42/45.5	46/49.5/50.5	51/54/57
Max Static Pressure	in WG	0.64	0.64	0.80
Field Drain Pipe Size O.D.	in (mm)	1 (25.4)	1 (25.4)	1 (25.4)

Performance may vary based on the compatible outdoor units. See respective pages for performance data.

**COMPATIBILITY:**

Indoor Unit	40MBDQ36---3	40MBDQ48---3	40MBDQ58---3
Outdoor Unit Single Zone	38MBRQ36A--3	38MBRQ48A--3	38MBRQ58A--3

Backward compatible with 38MBQ Single Zone Systems

PERFORMANCE SERIES  
40MBFQ CONSOLE



# Performance™ Floor Console Indoor Unit

## FEATURES OUTDOOR

- Modes: Cool, Heat, Dry, Fan, Auto
- Auto-restart function
- Capable to be mounted on floor and ceiling
- Louver control (fixed or swing)
- Three fan speeds
- *Follow Me* (senses temperature at handheld remote)
- Heating Setback (46°F Heating Mode)
- Quiet indoor operation, as low as 43 dB(A)
- Aluminum golden hydrophilic pre-coated fins

## COMPATIBLE WITH:

- 38MBR Outdoor Unit Single Zone (p 56)

Sizes: 36/48/58

## KEY FEATURES

### Outside Air Intake

Outside air is brought into the room via a connection pipe, which keeps the indoor air fresher and cleaner.

### Flexible Installation

Can be installed on the floor or ceiling depending on the application need.

## CONTROLS

Wireless Remote Controller included with indoor unit



Optional Wired Remote Controller KSACN0101AAA (Timer Function)

Optional Wired Remote Controller KSACN0501AAA (7-Day Programmable)

## ACCESSORIES

Wi-Fi® Kit

24V Interface for third-party thermostat compatibility

Performance™  
SERIES



Optional  
Wired Controller  
(7-Day Programmable)  
KSACN0501AAA



Wireless  
Remote  
Controller

**PERFORMANCE SERIES**  
40MBFQ CONSOLE

**SPECIFICATIONS:**

40MBFQ Console				
Heat Pump System				
Size		36	48	58
Indoor Model		40MBFQ36---3	40MBFQ48---3	40MBFQ58---3
Electrical				
Voltage, Phase, Cycle	V/Ph/Hz	208/230-1-60	208/230-1-60	208/230-1-60
Power Supply		Indoor unit powered from outdoor unit		
MCA	A	1.23	0.85	1.48
Controls				
Wireless Remote Controller (°F/°C Convertible)		Standard	Standard	Standard
Wired Remote Controller (°F/°C Convertible)		Optional	Optional	Optional
Operating Range				
Cooling Indoor DB Min–Max	°F (°C)	63~90 (17~32)	63~90 (17~32)	63~90 (17~32)
Heating Indoor DB Min–Max	°F (°C)	32~86 (0~30)	32~86 (0~30)	32~86 (0~30)
Piping				
Pipe Connection Size – Liquid	in (mm)	3/8 (9.52)	3/8 (9.52)	3/8 (9.52)
Pipe Connection Size – Suction	in (mm)	5/8 (16)	5/8 (16)	3/4 (19)
Indoor				
Unit Width	in (mm)	50.59 (1,285)	64.96 (1,650)	64.96 (1,650)
Unit Height	in (mm)	9.25 (235)	9.25 (235)	9.25 (235)
Unit Depth	in (mm)	26.57 (675)	26.57 (675)	26.57 (675)
Net Weight	lb (kg)	69 (31.3)	83.78 (38)	110 (50)
Number of Fan Speeds		3	3	3
Airflow (lowest to highest)	cfm	638/917/1,037	1,000/1,120/1,350	796/1,029/1,385
Sound Pressure (lowest to highest)	dB(A)	43/49/54	52/54/57	46/49/55
Air Throw Data	ft (m)	33 (10)	39 (12)	39 (12)
Field Drain Pipe Size O.D.	in (mm)	1 (25.4)	1 (25.4)	1 (25.4)

Performance may vary based on the compatible outdoor units. See respective pages for performance data.

**COMPATIBILITY:**

Indoor Unit	40MBFQ36---3	40MBFQ48---3	40MBFQ58---3
Outdoor Unit Single Zone	38MBRQ36A--3	38MBRQ48A--3	38MBRQ58A--3

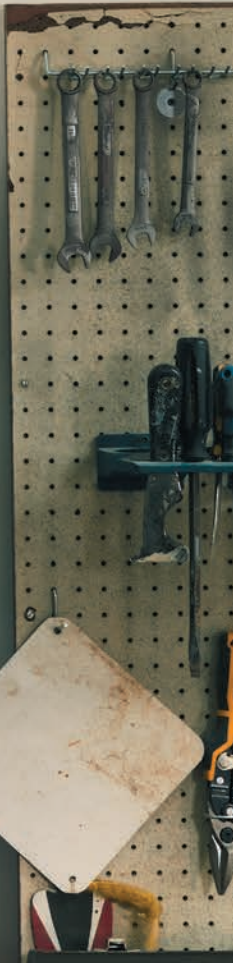



# Performance™ Outdoor Unit

Cooling Only – 24AHA4  
Heat Pump – 25HHA4

Fixed-Speed Compressor

14.0 SEER

8.2 HSPF

Sizes: 18/24/30/36/48/60



Ducted Indoor Units



## FEATURES

- Available in 208/230V-1, 208/230V-3 and 460V-3
- WeatherArmor™ cabinet
  - All-steel cabinet construction
  - Mesh coil guard
- Quiet outdoor operation, as low as 66 dB(A)
- Piping length up to 250 ft
- Cooling operating range -20°~125°F (-28°~52°C) (w/Low-Ambient Kit)
- Heating operating range 17°~75°F (-8°~24°C)

## COMPATIBLE WITH:

- Ducted Indoor Units

Performance  
SERIES

## PERFORMANCE SERIES 24AHA4 OUTDOOR UNIT

### SPECIFICATIONS:

24AHA4 Outdoor Unit							
<b>Cooling Only</b>							
<b>System</b>							
Size		18	24	30	36	36	36
Outdoor Model		24AHA418A003	24AHA424A003	24AHA430A003	24AHA436A003	24AHA436A005	24AHA436A006
<b>Electrical</b>							
Outdoor Voltage, Phase, Cycle	V/Ph/Hz	208/230-1-60	208/230-1-60	208/230-1-60	208/230-1-60	208/230-3-60	460-3-60
MCA (Outdoor)	A	11.8	14.1	18.3	18.8	12.5	7.6
MOCP – Fuse Rating (Outdoor)	A	20	25	30	30	20	15
<b>Operating Range</b>							
Cooling Outdoor DB Min–Max	°F	55~125 (–20°F w/Low-Ambient Kit)					
<b>Piping</b>							
Total Piping Length	ft	200	200	200	200	200	200
Drop (OD above ID)	ft	200	200	200	200	200	200
Lift (OD below ID)	ft	65	65	65	65	65	65
Outdoor Pipe Connection Size – Liquid	in	3/8	3/8	3/8	3/8	3/8	3/8
Outdoor Pipe Connection Size – Suction	in	5/8	3/4	3/4	7/8	7/8	7/8
<b>Refrigerant</b>							
Type		R-410A	R-410A	R-410A	R-410A	R-410A	R-410A
Charge	lb	6.4	6.5	8.6	8.9	8.9	8.9
<b>Compressor</b>							
Type		Scroll	Scroll	Scroll	Scroll	Scroll	Scroll
<b>Outdoor</b>							
Unit Width	in	36.9	36.9	44.5	44.5	44.5	44.5
Unit Height	in	31.1	31.1	37.1	37.1	37.1	37.1
Unit Depth	in	14.6	14.6	17.1	17.1	17.1	17.1
Net Weight	lb	146	148	183	184	184	184
Airflow	cfm	1,285	1,285	1,900	2,615	2,615	2,615
<b>Nominal Performance Ducted Fan Coils</b>							
Indoor Model		*	*	*	*	*	*
ENERGY STAR®		NO	NO	NO	NO	NO	NO
Cooling System Tons		1.5	2.0	2.5	3.0	3.0	3.0
Cooling Rated Capacity (Nominal)	Btu/h	18,000	24,000	29,600	35,400	35,400	35,400
SEER		14	14	14	14	14	14
EER		12.2	12.2	12.2	12.2	12.2	12.2

#### Tested AHRI Combination Ratings

Additional ratings and system combinations can be accessed via the Carrier database at: [MyCarrierRatings.com](http://MyCarrierRatings.com)

\*For performance data at specific application and/or design conditions with various indoor unit combinations, the equipment performance calculator can be accessed at: <http://rpmob.wrightsoft.com/>

**PERFORMANCE SERIES**  
**24AHA4 OUTDOOR UNIT**

**SPECIFICATIONS:**

24AHA4 Outdoor Unit							
Cooling Only							
System							
Size		48	48	48	60	60	60
Outdoor Model		24AHA448A003	24AHA448A005	24AHA448A006	24AHA460A003	24AHA460A005	24AHA460A006
Electrical							
Outdoor Voltage, Phase, Cycle	V/Ph/Hz	208/230-1-60	208/230-3-60	460-3-60	208/230-1-60	208/230-3-60	460-3-60
MCA (Outdoor)	A	24.3	18.3	8.4	31.1	21.4	9.7
MOCP – Fuse Rating (Outdoor)	A	40	30	15	50	35	15
Operating Range							
Cooling Outdoor DB Min–Max	°F	55~125 (–20°F w/Low-Ambient Kit)					
Piping							
Total Piping Length	ft	200	200	200	200	200	200
Drop (OD above ID)	ft	200	200	200	200	200	200
Lift (OD below ID)	ft	65	65	65	65	65	65
Outdoor Pipe Connection Size – Liquid	in	3/8	3/8	3/8	3/8	3/8	3/8
Outdoor Pipe Connection Size – Suction	in	7/8	7/8	7/8	1 1/8	1 1/8	1 1/8
Refrigerent							
Type		R-410A	R-410A	R-410A	R-410A	R-410A	R-410A
Charge	lb	9	9	9	10.6	10.6	10.6
Compressor							
Type		Scroll	Scroll	Scroll	Scroll	Scroll	Scroll
Outdoor							
Unit Width	in	44.5	44.5	44.5	44.5	44.5	44.5
Unit Height	in	37.1	37.1	37.1	43.1	43.1	43.1
Unit Depth	in	17.1	17.1	17.1	17.1	17.1	17.1
Net Weight	lb	213	213	213	245	245	245
Airflow	cfm	2,615	2,615	2,615	2,785	2,785	2,785
Nominal Performance Ducted Fan Coils							
Indoor Model		*	*	*	*	*	*
ENERGY STAR®		NO	NO	NO	NO	NO	NO
Cooling System Tons		3.8	3.8	3.8	4.8	4.8	4.8
Cooling Rated Capacity (Nominal)	Btu/h	45,000	45,000	45,000	57,000	57,000	57,000
SEER		14	14	14	14	14	14
EER		11.7	11.7	11.7	11.7	11.7	11.7

**Tested AHRI Combination Ratings**

Additional ratings and system combinations can be accessed via the Carrier database at: [www.MyCarrierRatings.com](http://www.MyCarrierRatings.com)

\*For performance data at specific application and/or design conditions with various indoor unit combinations, the equipment performance calculator can be accessed at: <http://rpmob.wrightsoft.com/>

**PERFORMANCE SERIES**  
**25HHA4 OUTDOOR UNIT**

**SPECIFICATIONS:**

25HHA4 Outdoor Unit							
Heat Pump							
System							
Size		18	24	30	36	36	36
Outdoor Model		25HHA418A003	25HHA424A003	25HHA430A003	25HHA436A003	25HHA436A005	25HHA436A006
Electrical							
Outdoor Voltage, Phase, Cycle	V/Ph/Hz	208/230-1-60	208/230-1-60	208/230-1-60	208/230-1-60	208/230-3-60	460-3-60
MCA (Outdoor)	A	11.8	16.5	17.2	19	12.8	7.6
MOCP – Fuse Rating (Outdoor)	A	20	25	30	30	20	15
Operating Range							
Cooling Outdoor DB Min–Max	°F	55~125 (–20°F w/Low-Ambient Kit)					
Heating Outdoor DB Min - Max	°F	17~75	17~75	17~75	17~75	17~75	17~75
Piping							
Total Piping Length	ft	200	200	200	200	200	200
Drop (OD above ID)	ft	200	200	200	200	200	200
Lift (OD below ID)	ft	65	65	65	65	65	65
Outdoor Pipe Connection Size – Liquid	in	3/8	3/8	3/8	3/8	3/8	3/8
Outdoor Pipe Connection Size – Suction	in	5/8	3/4	3/4	7/8	7/8	7/8
Refrigerent							
Type		R-410A	R-410A	R-410A	R-410A	R-410A	R-410A
Charge	lb	6.72	7.67	12.1	12.3	12.3	12.3
Compressor							
Type		Scroll	Scroll	Scroll	Scroll	Scroll	Scroll
Outdoor							
Unit Width	in	36.9	36.9	44.5	44.5	44.5	44.5
Unit Height	in	25.1	31.1	37.1	37.1	37.1	37.1
Unit Depth	in	14.6	14.6	17.1	17.1	17.1	17.1
Net Weight	lb	150	161	196	197	197	197
Airflow	cfm	1,285	1,285	2,615	2,615	2,615	2,615
Nominal Performance Ducted Fan Coils							
Indoor Model		*	*	*	*	*	*
ENERGY STAR®		NO	NO	NO	NO	NO	NO
Cooling System Tons		1.5	2.0	2.4	2.9	2.9	2.9
Cooling Rated Capacity	Btu/h	18,000	23,400	28,800	34,200	34,200	34,200
SEER		14	14	14	14	14	14
EER		11.5	11.5	12.5	12	12	11.5
Heating Rated Capacity	Btu/h	17,200	22,800	28,200	34,200	34,200	34,200
HSPF		8.2	8.2	8.5	8.5	8.5	8.2
COP	W/W	2.48	2.5	2.62	2.6	2.6	2.6

**Tested AHRI Combination Ratings**

Additional ratings and system combinations can be accessed via the Carrier database at: [www.MyCarrierRatings.com](http://www.MyCarrierRatings.com)

\*For performance data at specific application and/or design conditions with various indoor unit combinations, the equipment performance calculator can be accessed at: <http://rpmob.wrightsoft.com/>

**PERFORMANCE SERIES**  
**25HHA4 OUTDOOR UNIT**

**SPECIFICATIONS:**

25HHA4 Outdoor Unit							
Heat Pump							
System							
Size		48	48	48	60	60	60
Outdoor Model		25HHA448A003	25HHA448A005	25HHA448A006	25HHA460A003	25HHA460A005	25HHA460A006
Electrical							
Outdoor Voltage, Phase, Cycle	V/Ph/Hz	208/230-1-60	208/230-3-60	460-3-60	208/230-1-60	208/230-3-60	460-3-60
MCA (Outdoor)	A	28.8	18.6	8.6	33.4	22.9	10.6
MOCP – Fuse Rating (Outdoor)	A	50	30	15	50	40	15
Operating Range							
Cooling Outdoor DB Min–Max	°F	55~125 (–20°F w/Low-Ambient Kit)					
Heating Outdoor DB Min–Max	°F	17~75	17~75	17~75	17~75	17~75	17~75
Piping							
Total Piping Length	ft	200	200	200	200	200	200
Drop (OD above ID)	ft	200	200	200	200	200	200
Lift (OD below ID)	ft	65	65	65	65	65	65
Outdoor Pipe Connection Size – Liquid	in	3/8	3/8	3/8	3/8	3/8	3/8
Outdoor Pipe Connection Size – Suction	in	7/8	7/8	7/8	1 1/8	1 1/8	1 1/8
Refrigerant							
Type		R-410A	R-410A	R-410A	R-410A	R-410A	R-410A
Charge	lb	10.95	10.95	10.95	11.82	11.82	11.82
Compressor							
Type		Scroll	Scroll	Scroll	Scroll	Scroll	Scroll
Outdoor							
Unit Width	in	44.5	44.5	44.5	44.5	44.5	44.5
Unit Height	in	43.1	43.1	43.1	43.1	43.1	43.1
Unit Depth	in	17.1	17.1	17.1	17.1	17.1	17.1
Net Weight	lb	246	246	246	258	258	258
Airflow	cfm	2,785	2,785	2,785	2,785	2,785	2,785
Nominal Performance Ducted Fan Coils							
Indoor Model		*	*	*	*	*	*
<b>ENERGY STAR®</b>		<b>NO</b>	<b>NO</b>	<b>NO</b>	<b>NO</b>	<b>NO</b>	<b>NO</b>
Cooling System Tons		3.8	3.8	3.8	4.6	4.6	4.6
Cooling Rated Capacity	Btu/h	45,500	45,500	45,500	55,000	55,000	55,000
SEER		14	14	14	14	14	14
EER		11.5	11.5	11.5	11.5	11.5	11.5
Heating Rated Capacity	Btu/h	46,000	46,000	46,000	55,000	55,000	55,000
HSPF		8.2	8.2	8.2	8.2	8.2	8.2
COP	W/W	2.56	2.56	2.56	2.62	2.62	2.62

**Tested AHRI Combination Ratings**

Additional ratings and system combinations can be accessed via the Carrier database at: [www.MyCarrierRatings.com](http://www.MyCarrierRatings.com)

\*For performance data at specific application and/or design conditions with various indoor unit combinations, the equipment performance calculator can be accessed at: <http://rpmob.wrightsoft.com/>



**TOSHIBA CARRIER SERIES**  
RAV\*AT OUTDOOR UNIT



# Toshiba Carrier Light Commercial Heat Pump

## FEATURES

- Available in 208/230V
- Quiet outdoor operation, as low as 48 dB(A)
- Piping length 165~245 ft
- Cooling operating range  
0°~110°F (-17°~44°C)  
(w/wind baffles) – Sizes 18 & 24  
-13°~110°F (-25°~44°C)  
(w/wind baffles) – Sizes 36 & 42
- Heating operating range  
-4°~59°F (-20°~15°C)

Systems can be programmed to operate in cooling-only mode with heating locked out.

## COMPATIBLE WITH:

- RAV\*KRT High Wall (p 76)
- RAV\*UT Cassette (p 78)
- RAV\*BT Ducted (p 80)
- RAV\*CT Underceiling (p 82)

Inverter Compressor

Up to 21 SEER

Up to 12 HSPF

Sizes: 18/24/30/36/42



**High Wall**



**Cassette**



**Ducted**



**Console**

**TOSHIBA**  
*Carrier*

**TOSHIBA CARRIER SERIES**  
RAV\*AT OUTDOOR UNIT

**SPECIFICATIONS:**

RAV*AT Outdoor Unit						
Heat Pump System						
Size		18	24	30	36	42
Outdoor Model		RAV-SP180AT2-UL	RAV-SP240AT2-UL	RAV-SP300AT2-UL	RAV-SP360AT2-UL	RAV-SP420AT2-UL
Electrical						
Voltage, Phase, Cycle	V/Ph/Hz	208/230-1-60	208/230-1-60	208/230-1-60	208/230-1-60	208/230-1-60
MCA	A	17	24	24	24	24
MOCP – Fuse Rating	A	30	40	40	40	40
Operating Range						
Cooling Outdoor DB Min–Max	°F (°C)	23~110 (–5~44) [0 (–17) with wind baffle]		23~110 (–5~44) [–13 (–25) with wind baffle]		
Heating Outdoor DB Min–Max	°F (°C)	–4~59 (–20~15)	–4~59 (–20~15)	–4~59 (–20~15)	–4~59 (–20~15)	–4~59 (–20~15)
Piping						
Total Piping Length	ft (m)	165 (50.2)	165 (50.2)	245 (74.7)	245 (74.7)	245 (74.7)
Piping Lift*	ft (m)	100 (30.5)	100 (30.5)	100 (30.5)	100 (30.5)	100 (30.5)
Pipe Connection Size – Liquid	in (mm)	1/4 (6.35)	3/8 (9.52)	3/8 (9.52)	3/8 (9.52)	3/8 (9.52)
Pipe Connection Size – Suction	in (mm)	1/2 (12.7)	5/8 (16)	5/8 (16)	5/8 (16)	5/8 (16)
Refrigerant						
Type		R410A	R410A	R410A	R410A	R410A
Charge	lb (kg)	3.1	4.6	6.8	6.8	6.8
Compressor						
Type		Rotary Inverter	Rotary Inverter	Rotary Inverter	Rotary Inverter	Rotary Inverter
Outdoor						
Unit Width	in (mm)	30.7 (779)	35.4 (899)	35.4 (899)	35.4 (899)	35.4 (899)
Unit Height	in (mm)	21.7 (551)	35 (889)	52.8 (1,341)	52.8 (1,341)	52.8 (1,341)
Unit Depth	in (mm)	11.4 (289)	12.6 (289)	12.6 (320)	12.6 (320)	12.6 (320)
Net Weight	lb (kg)	98 (44.4)	144.5 (65.5)	211.5 (95.9)	211.5 (95.9)	211.5 (95.9)
Sound Pressure	dB(A)	48/49	49/50	50/51	52/52	52/52

\*Condensing unit above or below indoor unit.

**COMPATIBILITY:**

Indoor Unit		Outdoor Unit				
		RAV-SP180AT2-UL	RAV-SP240AT2-UL	RAV-SP300AT2-UL	RAV-SP360AT2-UL	RAV-SP420AT2-UL
High Wall	RAV-SP180KRT-UL	•				
	RAV-SP240KRT-UL		•			
Cassette	RAV-SP180UT-UL	•				
	RAV-SP240UT-UL		•			
	RAV-SP300UT-UL			•		
	RAV-SP360UT-UL				•	
Ducted	RAV-SP420UT-UL					
	RAV-SP181BT-UL	•				
	RAV-SP241BT-UL		•			
	RAV-SP301BT-UL			•		
Underceiling	RAV-SP361BT-UL				•	
	RAV-SP421BT-UL					•
	RAV-SP180CT-UL	•				
	RAV-SP240CT-UL		•			
	RAV-SP300CT-UL			•		
	RAV-SP360CT-UL				•	
	RAV-SP420CT-UL					•

**TOSHIBA CARRIER SERIES**  
RAV\*AT OUTDOOR UNIT

**PERFORMANCE:**

<b>RAV*KRT High Wall</b>			
Indoor Model		RAV-SP180KRT-UL	RAV-SP240KRT-UL
ENERGY STAR®		NO	NO
<b>High Wall</b>			
Cooling System Tons		1.5	2.1
Cooling Rated Capacity	Btu/h	18,000	25,000
Cooling Cap. Range Min–Max	Btu/h	3,560~23,500	4,100~32,600
SEER		19.5	16.7
EER		10	9.1
Heating Rated Capacity (47°F)	Btu/h	19,000	26,400
Heating Rated Capacity (17°F)	Btu/h	11,600	16,720
Heating Maximum Capacity (17°F)	Btu/h	16,500	24,500
Heating Maximum Capacity (5°F)	Btu/h	11,600	16,900
Heating Cap. Range Min–Max	Btu/h	2,250~23,000	3,480~30,400
HSPF		11.5	9.8
COP (47°F)	W/W	3.12	2.70
COP (17°F)	W/W	2.09	2.02
COP (5°F)	W/W	1.80	1.76

**PERFORMANCE:**

<b>RAV*UT Cassette</b>						
Indoor Model		RAV-SP180UT-UL	RAV-SP240UT-UL	RAV-SP300UT-UL	RAV-SP360UT-UL	RAV-SP420UT-UL
ENERGY STAR®		NO	NO	YES	YES	NO
<b>Cassette</b>						
Cooling System Tons		1.6	2.1	2.7	3.0	3.4
Cooling Rated Capacity	Btu/h	19,000	25,000	32,000	36,500	40,800
Cooling Cap. Range Min–Max	Btu/h	3,800~21,600	5,670~28,500	10,470~36,460	11,260~41,500	10,990~46,100
SEER		20.5	20.7	21.0	21.0	19.0
EER		10.7	11.0	14.0	13.0	11.5
Heating Rated Capacity (47°F)	Btu/h	18,800	26,000	33,400	36,000	46,000
Heating Rated Capacity (17°F)	Btu/h	11,100	15,390	19,280	22,800	24,420
Heating Maximum Capacity (17°F)	Btu/h	16,400	24,200	27,300	32,000	34,400
Heating Maximum Capacity (5°F)	Btu/h	11,300	15,800	18,700	22,400	24,600
Heating Cap. Range Min–Max	Btu/h	3,100~21,200	4,100~29,900	8,500~38,100	8,240~40,300	8,400~51,500
HSPF		12	10	11	12	11
COP (47°F)	W/W	3.73	3.36	4.24	4.00	3.51
COP (17°F)	W/W	2.62	2.43	2.90	2.82	2.84
COP (5°F)	W/W	2.21	2.12	2.04	2.04	2.43

**TOSHIBA CARRIER SERIES**  
RAV\*AT OUTDOOR UNIT

**PERFORMANCE:**

RAV*BT Ducted						
Indoor Model		RAV-SP181BT-UL	RAV-SP241BT-UL	RAV-SP301BT-UL	RAV-SP361BT-UL	RAV-SP421BT-UL
ENERGY STAR®		NO	NO	YES	YES	NO
Ducted						
Cooling System Tons		1.5	2.0	2.5	3.0	3.5
Cooling Rated Capacity	Btu/h	18,000	24,000	30,000	36,000	42,000
Cooling Cap. Range Min–Max	Btu/h	9,600~19,200	14,000~25,800	18,000~32,500	20,800~39,200	23,700~45,400
SEER		17.0	18.2	20.0	19.7	18.7
EER		8.6	9.6	13.0	12.5	10.6
Heating Rated Capacity (47°F)	Btu/h	20,000	27,000	34,000	40,000	47,500
Heating Rated Capacity (17°F)	Btu/h	11,000	19,800	20,700	21,500	32,300
Heating Maximum Capacity (17°F)	Btu/h	12,400	16,740	21,080	24,800	29,450
Heating Maximum Capacity (5°F)	Btu/h	9,400	12,690	15,980	18,800	22,325
Heating Cap. Range Min–Max	Btu/h	11,000~22,500	19,800~30,800	20,700~35,000	21,500~41,500	32,300~49,000
HSPF		10.8	9.6	11.8	11.5	12.0
COP (47°F)	W/W	2.85	2.89	3.75	3.69	3.25
COP (17°F)	W/W	2.19	2.24	2.89	2.86	2.51
COP (5°F)	W/W	1.85	1.87	2.43	2.40	2.11

**PERFORMANCE:**

RAV*CT Underceiling						
Indoor Model		RAV-SP180CT-UL	RAV-SP240CT-UL	RAV-SP300CT-UL	RAV-SP360CT-UL	RAV-SP420CT-UL
ENERGY STAR®		NO	NO	YES	NO	NO
Underceiling						
Cooling System Tons		1.4	2.0	2.5	3.0	3.4
Cooling Rated Capacity	Btu/h	17,000	23,700	30,000	36,000	41,000
Cooling Cap. Range Min–Max	Btu/h	3,750~19,400	4,700~26,900	11,340~34,200	11,960~41,000	10,980~46,700
SEER		17.0	19.5	20.6	20.4	18.8
EER		8.6	9.0	13.0	12.0	9.7
Heating Rated Capacity (47°F)	Btu/h	19,000	28,900	29,800	38,000	44,800
Heating Rated Capacity (17°F)	Btu/h	17,405	18,930	21,710	25,280	28,100
Heating Maximum Capacity (17°F)	Btu/h	17,600	28,000	36,100	36,100	39,200
Heating Maximum Capacity (5°F)	Btu/h	12,700	19,700	23,500	23,500	26,700
Heating Cap. Range Min–Max	Btu/h	2,800~21,700	3,600~32,400	9,900~33,700	11,700~42,750	9,100~50,500
HSPF		10.8	10.3	10.3	11.0	11.0
COP (47°F)	W/W	2.98	2.89	3.99	3.56	3.27
COP (17°F)	W/W	2.85	2.46	3.30	2.76	2.74
COP (5°F)	W/W	2.12	1.77	1.96	1.96	2.35



# Toshiba Carrier High Wall Indoor Unit

## FEATURES

- Available in 208/230V
- Modes: Cool, Heat, Dry, Fan, Auto
- Turbo Mode
- One-touch memory
- Sleep Mode
- Filter maintenance indicator
- Quiet indoor operation, as low as 38 dB(A)

## COMPATIBLE WITH:

- RAV\*AT Outdoor Unit  
Single Zone (p 72)

Sizes: 18/24

## CONTROLS

Wireless Remote Controller included with indoor unit



Optional Wired Remote Controller

## ACCESSORIES

Condensate Pump (230V optional)

Insulated 25' Line Set

Systems can be programmed to operate in cooling-only mode with heating locked out



Optional  
Wired Controller  
(7-Day Programmable)  
RBC-AMS54E-UL



Standard  
Wireless  
Controller

**TOSHIBA**  
*Carrier*



**TOSHIBA CARRIER SERIES**  
RAV\*KRT HIGH WALL

**SPECIFICATIONS:**

<b>RAV*KRT High Wall</b>			
<b>Heat Pump System</b>			
Size		18	24
Indoor Model		RAV-SP180KRT-UL	RAV-SP240KRT-UL
<b>Electrical</b>			
Voltage		208/230-1-60	208/230-1-60
Power Supply		Indoor unit powered from outdoor unit	
<b>Controls</b>			
Wireless (°C, °F, Convertible)		Standard – Convertible	
Wired (°C, °F, Convertible)		Optional – Convertible	
<b>Operating Range</b>			
Cooling Indoor DB Min–Max	°F (°C)	69~90 (21~32)	
Heating Indoor DB Min–Max	°F (°C)	59~83 (15~28)	
<b>Piping</b>			
Pipe Connection Size – Liquid	in (mm)	1/4 (6.35)	3/8 (9.52)
Pipe Connection Size – Suction	in (mm)	1/2 (12.7)	5/8 (16)
<b>Indoor</b>			
Unit Width	in (mm)	41.3 (1,049)	41.3 (1,049)
Unit Height	in (mm)	12.6 (320)	12.6 (320)
Unit Depth	in (mm)	9 (228)	9 (228)
Net Weight	lb (kg)	31 (14)	31 (14)
Number of Fan Speeds		3	3
Airflow (lowest to highest)	cfm	400/430/490	401/460/560
Sound Pressure (lowest to highest)	dB(A)	38/41/43	38/41/46

Performance may vary based on the compatible outdoor units. See respective pages for performance data.

**COMPATIBILITY:**

Indoor Unit	RAV-SP180KRT-UL	RAV-SP240KRT-UL
Outdoor Unit Single Zone	RAV-SP180AT2-UL	RAV-SP240AT2-UL



# Toshiba Carrier Cassette Indoor Unit

## FEATURES

- Available in 208/230V
- Modes: Cool, Heat, Dry, Fan, Auto
- One-touch memory
- Sleep Mode
- Filter maintenance indicator
- Built-in condensate lift pump
- Outside air intake
- Branch duct capability
- Independent louver control (fixed or swing)
- Power-saving Mode
- Quiet indoor operation, as low as 32 dB(A)

## COMPATIBLE WITH:

- RAV\*AT Outdoor Unit Single Zone (p 72)

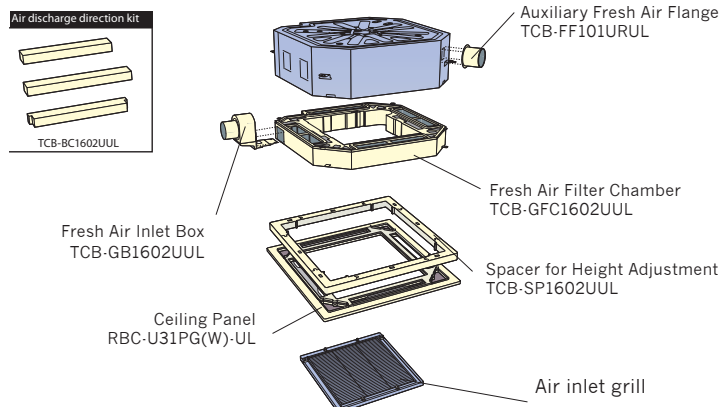

Sizes: 18/24/30/36/42

## CONTROLS

**Controller not included with indoor unit.  
Must order:**

Optional Wireless Remote Controller

Optional Wired Remote Controller



## ACCESSORIES

Condensate Pump (230V optional)

Insulated 25' Line Set

Outside air intake

Air-discharge direction kit

Systems can be programmed to operate in cooling-only mode with heating locked out



**Optional  
Wired Controller  
(7-Day Programmable)  
RBC-AMS54E-UL**



**Optional  
Wireless  
Controller**

**TOSHIBA**  
*Carrier*

**TOSHIBA CARRIER SERIES**  
RAV\*UT CASSETTE

**SPECIFICATIONS:**

RAV*UT Cassette						
Heat Pump System						
Size		18	24	30	36	42
Indoor Model		RAV-SP180UT-UL	RAV-SP240UT-UL	RAV-SP300UT-UL	RAV-SP360UT-UL	RAV-SP420UT-UL
Electrical						
Voltage		208/230-1-60	208/230-1-60	208/230-1-60	208/230-1-60	208/230-1-60
Power Supply		Indoor unit powered from outdoor unit				
Controls						
Wireless (°C, °F, Convertible)		Optional – Dedicated °F or °C				
Wired (°C, °F, Convertible)		Optional – Convertible				
Operating Range						
Cooling Indoor DB Min–Max	°F (°C)	69~90 (21~32)	69~90 (21~32)	69~90 (21~32)	69~90 (21~32)	69~90 (21~32)
Heating Indoor DB Min–Max	°F (°C)	59~83 (15~28)	59~83 (15~28)	59~83 (15~28)	59~83 (15~28)	59~83 (15~28)
Piping						
Pipe Connection Size – Liquid	in (mm)	1/4 (6.35)	3/8 (9.52)	3/8 (9.52)	3/8 (9.52)	3/8 (9.52)
Pipe Connection Size – Suction	in (mm)	1/2 (12.7)	5/8 (16)	5/8 (16)	5/8 (16)	5/8 (16)
Indoor						
Unit Width	in (mm)	33.1 (840)	33.1 (840)	33.1 (840)	33.1 (840)	33.1 (840)
Unit Height	in (mm)	10.1 (256)	10.1 (256)	12.6 (320)	12.6 (320)	12.6 (320)
Unit Depth	in (mm)	33.1 (840)	33.1 (840)	33.1 (840)	33.1 (840)	33.1 (840)
Net Weight	lb (kg)	44 (19.9)	44 (19.9)	53 (24)	53 (24)	53 (24)
Grille Dimensions (W X H X D)	in (mm)	37.4x1.2x37.4 (949x30x949)				
Grille Net Weight	lb (kg)	10 (4.5)				
Number of Fan Speeds		3	3	3	3	3
Airflow (lowest to highest)	cfm	450/500/600	460/550/700	670/820/1150	700/820/1200	700/820/1200
Sound Pressure (lowest to highest)	dB(A)	34/35/37	34/35/39	36/40/46	38/41/47	38/41/47

Performance may vary based on the compatible outdoor units. See respective pages for performance data.

**COMPATIBILITY:**

Indoor Unit	RAV-SP180UT-UL	RAV-SP240UT-UL	RAV-SP300UT-UL	RAV-SP360UT-UL	RAV-SP420UT-UL
Outdoor Unit Single Zone	RAV-SP180AT2-UL	RAV-SP240AT2-UL	RAV-SP300AT2-UL	RAV-SP360AT2-UL	RAV-SP420AT2-UL



# Toshiba Carrier Ducted Indoor Unit

## FEATURES

- Available in 208/230V
- Modes: Cool, Heat, Dry, Fan, Auto
- Up to 0.46 in WG
- Rear or bottom return
- Outside air intake
- Built-in condensate lift pump
- Quiet indoor operation, as low as 30 dB(A)

## COMPATIBLE WITH:

- RAV\*AT Outdoor Unit  
Single Zone (p 72)

Sizes: 18/24/30/36/42

## CONTROLS

**Controller not included with indoor unit.  
Must order:**

Optional Wireless Remote Controller

Optional Wired Remote Controller



## ACCESSORIES

Condensate Pump (208–230V optional)

Systems can be programmed to operate in cooling-only mode with heating locked out



**Optional  
Wired Controller  
(7-Day Programmable)  
RBC-AMS54E-UL**



**Optional  
Wireless  
Controller**

**TOSHIBA**  
*Carrier*

**TOSHIBA CARRIER SERIES**  
RAV\*BT DUCTED STYLE

**SPECIFICATIONS:**

RAV*BT Ducted Style						
Heat Pump System						
Size		18	24	30	36	42
Indoor Model		RAV-SP181BT-UL	RAV-SP241BT-UL	RAV-SP301BT-UL	RAV-SP361BT-UL	RAV-SP421BT-UL
Electrical						
Voltage		208/230-1-60	208/230-1-60	208/230-1-60	208/230-1-60	208/230-1-60
Power Supply		Indoor unit powered from outdoor unit				
Controls						
Wireless (°C, °F, Convertible)		Optional – Dedicated °F or °C				
Wired (°C, °F, Convertible)		Optional – Convertible				
Operating Range						
Cooling Indoor DB Min–Max	°F (°C)	69~90 (21~32)	69~90 (21~32)	69~90 (21~32)	69~90 (21~32)	69~90 (21~32)
Heating Indoor DB Min–Max	°F (°C)	59~83 (15~28)	59~83 (15~28)	59~83 (15~28)	59~83 (15~28)	59~83 (15~28)
Piping						
Pipe Connection Size – Liquid	in (mm)	1/4 (6.35)	3/8 (9.52)	3/8 (9.52)	3/8 (9.52)	3/8 (9.52)
Pipe Connection Size – Suction	in (mm)	1/2 (12.7)	5/8 (16)	5/8 (16)	5/8 (16)	5/8 (16)
Indoor						
Unit Width	in (mm)	12.6 (320)	12.6 (320)	12.6 (320)	12.6 (320)	12.6 (320)
Unit Height	in (mm)	27.6 (700)	39.4 (1,000)	53.2 (1,350)	53.2 (1,350)	53.2 (1,350)
Unit Depth	in (mm)	31.5 (800)	31.5 (800)	31.5 (800)	31.5 (800)	31.5 (800)
Net Weight	lb (kg)	73 (33)	93 (42)	119 (54)	119 (54)	119 (54)
Number of Fan Speeds		3	3	3	3	3
Airflow (lowest to highest)	cfm	341/406/459	529/618/706	765/853/953	929/1,041/1,165	929/1,041/1,165
Sound Pressure (lowest to highest)	dB(A)	30/33/36	32/34/36	33/36/39	34/37/40	34/37/40
Max Static Pressure	in WG	0.45	0.45	0.46	0.46	0.46
Field Drain Pipe Size O.D.	in (mm)	1 (25.4)	1 (25.4)	1 (25.4)	1 (25.4)	1 (25.4)

Performance may vary based on the compatible outdoor units. See respective pages for performance data.

**COMPATIBILITY:**

Indoor Unit	RAV-SP181BT-UL	RAV-SP241BT-UL	RAV-SP301BT-UL	RAV-SP361BT-UL	RAV-SP421BT-UL
Outdoor Unit Single Zone	RAV-SP180AT2-UL	RAV-SP240AT2-UL	RAV-SP300AT2-UL	RAV-SP360AT2-UL	RAV-SP420AT2-UL





# Toshiba Carrier Underceiling Indoor Unit

## FEATURES

- Available in 208/230V
- Modes: Cool, Heat, Dry, Fan, Auto
- Outside air intake
- Power-saving Mode
- Filter maintenance indicator
- Quiet indoor operation, as low as 34 dB(A)

## COMPATIBLE WITH:

- RAV\*AT Outdoor Unit Single Zone (p 72)

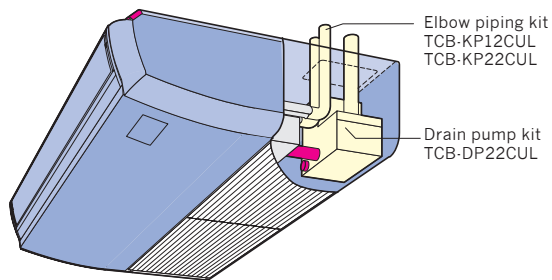

Sizes: 18/24/30/36/42

## CONTROLS

**Controller not included with indoor unit. Must order:**

Optional Wireless Remote Controller

Optional Wired Remote Controller



## ACCESSORIES

Condensate Pump (208-230V optional)

Elbow Piping Kit

Systems can be programmed to operate in cooling-only mode with heating locked out



**Optional  
Wired Controller  
(7-Day Programmable)  
RBC-AMS54E-UL**



**Optional  
Wireless  
Controller**

**TOSHIBA**  
*Carrier*

**TOSHIBA CARRIER SERIES**  
RAV\*CT UNDERCEILING

**SPECIFICATIONS:**

RAV*CT Underceiling						
Heat Pump System						
Size		18	24	30	36	42
Indoor Model		RAV-SP180CT-UL	RAV-SP240CT-UL	RAV-SP300CT-UL	RAV-SP360CT-UL	RAV-SP420CT-UL
Electrical						
Voltage		208/230-1-60	208/230-1-60	208/230-1-60	208/230-1-60	208/230-1-60
Power Supply		Indoor unit powered from outdoor unit				
Controls						
Wireless (°C, °F, Convertible)		Optional – Dedicated °F or °C				
Wired (°C, °F, Convertible)		Optional – Convertible				
Operating Range						
Cooling Indoor DB Min–Max	°F (°C)	69~90 (21~32)	69~90 (21~32)	69~90 (21~32)	69~90 (21~32)	69~90 (21~32)
Heating Indoor DB Min–Max	°F (°C)	59~83 (15~28)	59~83 (15~28)	59~83 (15~28)	59~83 (15~28)	59~83 (15~28)
Piping						
Pipe Connection Size – Liquid	in (mm)	1/4 (6.35)	3/8 (9.52)	3/8 (9.52)	3/8 (9.52)	3/8 (9.52)
Pipe Connection Size – Suction	in (mm)	1/2 (12.7)	5/8 (16)	5/8 (16)	5/8 (16)	5/8 (16)
Indoor						
Unit Width	in (mm)	35.8 (909)	46.5 (1,181)	62.8 (1,595)	62.8 (1,595)	62.8 (1,595)
Unit Height	in (mm)	8.3 (210)	8.3 (210)	8.3 (210)	8.3 (210)	8.3 (210)
Unit Depth	in (mm)	26.8 (680)	26.8 (680)	26.8 (680)	26.8 (680)	26.8 (680)
Net Weight	lb (kg)	46 (20.8)	55 (24.9)	73 (33.1)	73 (33.1)	73 (33.1)
Number of Fan Speeds		3	3	3	3	3
Airflow (lowest to highest)	cfm	320/360/410	470/530/590	660/750/860	730/820/950	730/820/950
Sound Pressure (lowest to highest)	dB(A)	34/37/40	37/40/42	38/42/45	40/44/47	40/44/47

Performance may vary based on the compatible outdoor units. See respective pages for performance data.

**COMPATIBILITY:**

Indoor Unit	RAV-SP180CT-UL	RAV-SP240CT-UL	RAV-SP300CT-UL	RAV-SP360CT-UL	RAV-SP420CT-UL
Outdoor Unit Single Zone	RAV-SP180AT2-UL	RAV-SP240AT2-UL	RAV-SP300AT2-UL	RAV-SP360AT2-UL	RAV-SP420AT2-UL

## 24V INTERFACE



# 24V Interface for Third-Party Thermostat

### FEATURES

- Control the Ductless system using a third-party thermostat
- Available in 115V and 208/230V
- 4 fan control speeds
- Auto, High, Med, Low
- Single Zone applications only
- One 24V Interface Kit per system
- Keeps the inverter compressor operating as a variable-speed system
- Rated for outdoor and indoor mounting
- Dry mode contact for active dehumidification control
- Remote ON/OFF contact
- Auxiliary Heat control through the thermostat
- Diagnostic code display LEDs
- Power supplied through the outdoor unit

### COMPATIBLE WITH:

- 40MPHA High Wall (p 20)
- 40MAQ High Wall\* (p 26)
- 40MBCQ Cassette (p 28)
- 40MBDQ Ducted (p 30)
- 40MBFQ Console (p 32)
- 40MHH High Wall (p 38)

\*Compatible indoor units starting with Serial Number 4216V10001

\*\*Compatible indoor units starting with Serial Number 4616V10001

**KSAIC0101115 Ductless Indoor + Outdoor Single Zone 115V**

**KSAIC0101230 Ductless Indoor + Outdoor Single Zone 208-230V**



# Multi-Family Air Handler

**KSAIC0201230 Ductless Outdoor\*\*\* Matched With Multi-Family Air Handler**



## FEATURES

- Match a Multi-Family Air Handler with a Single Zone Outdoor and a third-party thermostat
- Available in 208/230V
- Single Zone applications only
- One 24V Interface Kit per system
- Keeps the inverter compressor operating as a variable-speed system
- Rated for outdoor and indoor mounting
- Remote ON/OFF contact
- Auxiliary Heat control through the thermostat
- Diagnostic code display LEDs
- Achieves up to 18 SEER and up to 12 HSPF
- Separate power necessary for the indoor unit and the outdoor unit

\*\*\*Matched with 38MA\*R Single Zone





## Standard Features Glossary

### 24-Hour Timer

Set the unit to start and stop automatically in a 24-hour period.

### Airflow Panel

360° air outlet creates a soft and gentle airflow, which circulates throughout the whole space and provides an even temperature distribution in the room.

### Auto Defrosting

Prevents the evaporator from freezing and maintains dehumidifying effect in low temperature environments.

### Auto Restart Function

If the air conditioner shuts off unexpectedly due to a power outage, it will restart with the previous settings automatically when the power resumes.

### Built-In Basepan Heater

A heating belt is fitted on the base plate of the outdoor unit to prevent water accumulation, which improves heat transfer efficiency.

### Built-In Condensate Lift Pump

A powerful, built-in drain pump can lift the condensing water up to 29 inches.

### Control Box Inside the Cassette

Easy maintenance with the box right inside the Cassette indoor unit. The integrated design provides a more compact size for easier installation.

### Convenient Temperature Controls

An intuitive, easy-to-use remote control displays temperature and other functions on a bright, clear LCD screen.

### Convertible Return Air Inlet

The air inlet can be installed either at the back or bottom of the ducted unit, allowing for flexible installation to meet the needs of each job.

### Crankcase Heater

A heating belt is fitted on the compressor to prevent frosting water accumulation, which improves heat transfer efficiency.

### Diamond Outdoor Unit Design

An innovative outdoor unit reduces noise level by more than 3 dB(A), with higher reliability, easier maintenance and improved performance.

### Eco Mode

Provides the ultimate energy savings and a comfortable sleeping environment with an intelligent eight-hour night cycle program that saves up to 60% of energy.

### Extra-Low Temperature Heating

When it's cold outside, it's warm inside. High Tier and Mid-Tier Ductless systems can be used as a primary heat source, with heat output down to -22° F.

### Follow Me

A temperature sensor built into the Remote Controller will sense its surrounding temperature. The unit will adjust the room temperature more accurately to give you comfort.

### Golden Fin Anti-Corrosive Coating

An anti-corrosive coating on the condenser stands up to harsh weather, salty air and the elements, preventing build-up of corrosive mold and bacteria while improving heat transfer efficiency.

### High Ambient Cooling

The indoor space can be cooled to a desired, comfortable indoor temperature, even when outside temperatures reach up to 122° F.

### High Heating Operation

The High Tier and Mid-Tier systems can be a primary heat source, with High Heating down to -22° F, so when it's cold outside, it's warm inside.

### Independent Vane Control

Airflow direction from individual outlets can be controlled separately to achieve the optimal airflow based on a room's configuration.

### Inverter Technology

With the Inverter, the outdoor unit uses only the energy required to meet the desired temperature requirements of the indoor unit, thus lowering energy consumption.

### Louver Position Memory

A horizontal louver will automatically move to the same position that was set the last time the unit was on.

### Low Ambient Cooling

Even when it's cold outside, but warm inside, the air conditioner will keep the area cool – perfect for server rooms and commercial kitchens.

### Refrigerant Leak Detection

The indoor unit shows error code "EC" and stops automatically when refrigerant leakage is detected. This protects the compressor from high temperature damage due to refrigerant leakage.

### Single and Multi-zone Compatible

A Single Zone outdoor unit can be paired with any indoor unit type. One Multi-zone unit can be leveraged for up to five indoor units of any style.

### Sleep Mode

This function enables the system to automatically increase cooling or decrease heating by around four degrees for the first two hours, then holds steady for the next five hours. After that, it will switch off. This function achieves both energy savings and comfort at night.

### Stepless Frequency Adjustment

Precise control maintains a stable and constant room temperature while reducing the sound level and saving energy.

### Two-Way Draining

Connections, piping and drainage can be installed from both the left and right on the High Wall.

### Universal Matching

Get maximum flexibility with up to five different indoor units connected to one outdoor unit. Maintain a different temperature in each room for ultimate comfort, with the best indoor unit choice for each. Universal matching units are also available for Single Zone outdoor units. One outdoor unit can match any type of indoor unit.

### Wired Remote Controller

Compared to an infrared remote controller, a Wired Controller can be fixed on the wall and makes air conditioner operation more convenient for larger setups or ducted units.



[carrierductless.com](http://carrierductless.com)

---

**CARRIER CORPORATION**

3300 Riverwood Parkway  
Suite 900  
Atlanta, GA 30339

©Carrier Corporation 2019

01-DLS-038-10  
1/2019

